

Sound Module **MDL1**

Owner's Manual

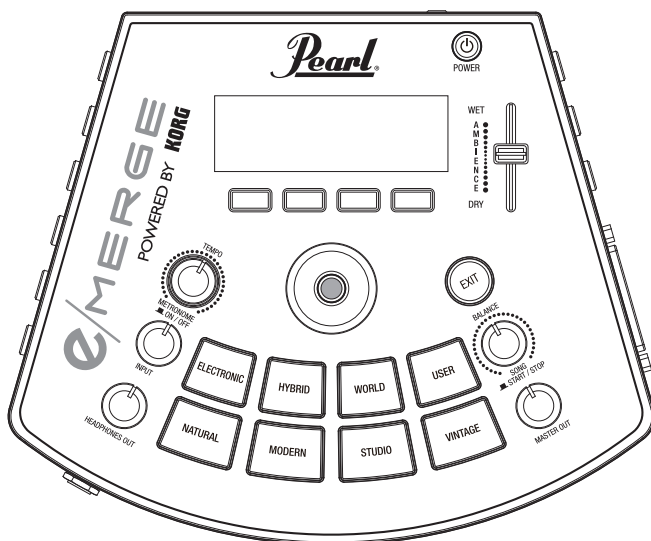

Table of Contents

Introduction	4
Main features	4
Main functions	4
Other functions	4
Part Names and Functions	5
Top panel	5
Rear and side panel	7
Preparations	8
Settings	8
Cautions during connection	8
Steps for connecting	8
Connecting the included AC adapter	10
Connecting audio devices	10
Connecting to a computer or MIDI device	11
Turning the power on and off	12
Turning the power on	12
Turning the power off	12
Changing the drum kits	13
Configuration Guide	14
CUSTOM: Drum Kit User Edit	14
Displaying and editing using the edit menu	14
Storing a drum kit	16
Editing the detailed parameters	17
Drum kit parameter edit menu	19
[METRONOME] Metronome function	24
Using metronome	24
Detailed metronome settings	24
Storing a metronome project	25
Selecting a metronome project	26
Editing a metronome project	27
Metronome parameter edit menu	29
[SONG] Song function	30
Registering a WAV file in a song project	30
Selecting and playing back a song project	32
Song parameter edit menu	34

[UTILITY] Other functions and settings -----	35
Selecting a function -----	35
Utilities -----	35
TRAINING -----	35
TRIGGER PAD -----	40
HI-HAT CALIBRATION -----	42
PAD FUNCTION -----	44
DIRECT OUT -----	45
METRONOME -----	45
INPUT GAIN -----	46
MIDI -----	46
DATA MANAGEMENT -----	48
User Kit -----	49
All Systems-----	51
Internal Rec File-----	52
All Metronome Projects-----	53
AUTO POWER OFF -----	55
DISPLAY -----	55
FACTORY RESET -----	56
PROTECT -----	56
USB MEMORY FORMAT -----	57
SYSTEM INFO -----	57
Appendix -----	58
Troubleshooting -----	58
Error messages -----	60
Preset Drum Kit List -----	61
Inst List -----	68
MFX Type List -----	75
Metronome sound list -----	76
Mixer block diagram -----	77
Files stored to USB flash drives -----	78
Pad Assignment Chart -----	79
Specifications -----	80
Operating requirements -----	80

Introduction

Thank you for purchasing the Pearl e/MERGE Sound Module MDL1 Powered by Korg. To ensure trouble-free enjoyment of this module, please read this manual carefully and use the product as directed. Also, be sure to keep this manual in a safe place for reference.

Main features

e/MERGE is an electronic drum kit with a completely new concept, developed by Pearl in collaboration with Korg.

The e/MERGE features rapid trigger response and high quality sounds using “Wave Trigger Technology”. This newly developed process is based on Korg’s groundbreaking innovation used in the original Wavedrum. Using this technology, the player is introduced to an enhanced level of performance that feels like an acoustic drum set. The pads have a comfortable stroke feel and coupled with the MDL1 module provides a truly natural playing experience.

Main functions

- This module features five kits in seven categories, for a total of 35 preset kits. These kits are selectable with each press of a category button. Kits can also be selected using the dial.
- There are a total of 700 instrument types, which can be freely combined and stored in the “USER” category in one of 50 user kits. These kits are recalled using either one of the category buttons or the dial.
- The AMBIENCE fader can be moved up and down to easily adjust the balance of the real ambience recorded by the mic.

Other functions

- **Direct out function:** In addition to the MASTER OUT L/MONO and R jacks, there are eight DIRECT OUT jacks to which each pad can be assigned for recording or live performance.
- **Metronome function:** This module features a metronome with a dedicated knob to control the metronome tempo. Up to 50 metronome projects can be registered. Each project has its own project name, tempo, time signature and sound. Tap tempo can also be used.
- **Song function:** The e/MERGE can play back WAV files from a USB flash drive. You can also create a separate click track that only you can hear when playing live. The knobs on this module can be used to easily control the balance for each track.
- **Training function:** This module allows you to practice along with your portable audio player or smartphone plugged into the AUX IN jack, or with a song played back from your computer connected via the USB audio port. You can also record your playing along with music to the internal memory of e/MERGE.

Part Names and Functions

Top panel

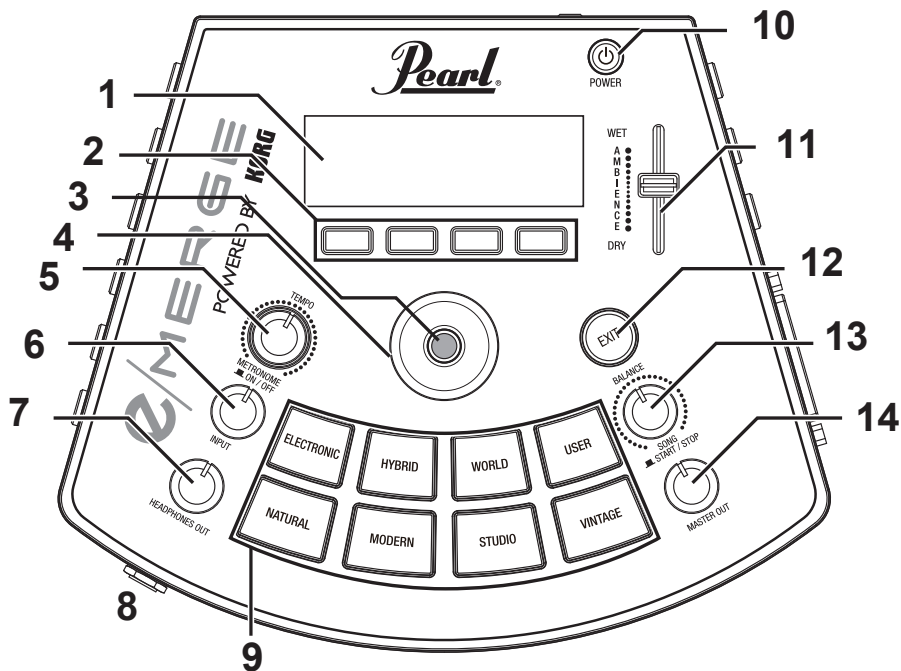

1. Display

Shows the drum kit name, tempo information, and each parameter.

2. Function buttons

The functions of these buttons changes according to the status of the display. The functions are shown at the lower part of the display.

3. ENTER button

The ENTER button is used to confirm parameter settings.

4. Dial

On the top page, turning the dial will change the drum kit. On each menu page, the dial is used to set the parameters.

5. TEMPO knob, METRONOME ON/OFF button

Turn the knob to adjust the tempo.

Also, pushing the knob will switch the metronome on or off.

6. INPUT knob

This adjusts the input levels for the AUX IN jack and the USB audio signal, as well as the metronome volume.

This is also used to adjust the volume of WAV files saved to USB flash drive using the song or training functions.

Note: The sound output from the DIRECT OUT jacks cannot be adjusted.

7. HEADPHONES OUT knob

This adjusts the output volume from the  (Headphones) jack.

8. (Headphones) jack

Connect stereo headphones here.

9. Category buttons

These buttons select the drum kit. Pressing a button within a category will select the next drum kit within that category, in sequential order.

10. Power button

Turns the power on/off (→ p.12 “Turning the power on and off”).

11. AMBIENCE fader

This adjusts the ambience effect (the presence of the sound) for the drum kit. This gives the sound greater depth and adds reverberation.

Note: The ambience effect cannot be used on some sounds.

Note: The AMBIENCE fader may be set to not function on some preset drum kits (→ p.61 “Preset Drum Kit List”).

To enable the AMBIENCE fader, set the “Inst Amb Max Level” in the CUSTOM menu to a value greater than “Inst Amb Min Level.” (→ p.23 “Inst Amb Max Level”)

Note: When you have modified a drum kit or when you press the CUSTOM button to enter user edit mode, the ambience level will be set to the ambience level saved in the drum kit (→ p.23 “Kit Amb Level”). For this reason, the actual value may differ from the value indicated by the AMBIENCE fader position.

12. EXIT button

Use this button to return to the previous page or to cancel setting the parameters.

13. BALANCE knob, SONG START/STOP button

This adjusts the volume balance sent to the headphones for each track using the song function.

The music track volume will increase as you turn the knob to the left, and decrease as you turn the knob to the right. Conversely, the click track volume will decrease as you turn the knob to the left, and increase as you turn the knob to the right.

Also, push this knob (SONG START/STOP button) to start and stop the song.

 The click track sound will not be routed to the MASTER OUT L/MONO, R jacks.

14. MASTER OUT knob

Adjusts the output volume from the MASTER OUT L/MONO, R jacks.

Note: The sound output from the DIRECT OUT jacks cannot be adjusted.

Rear and side panel

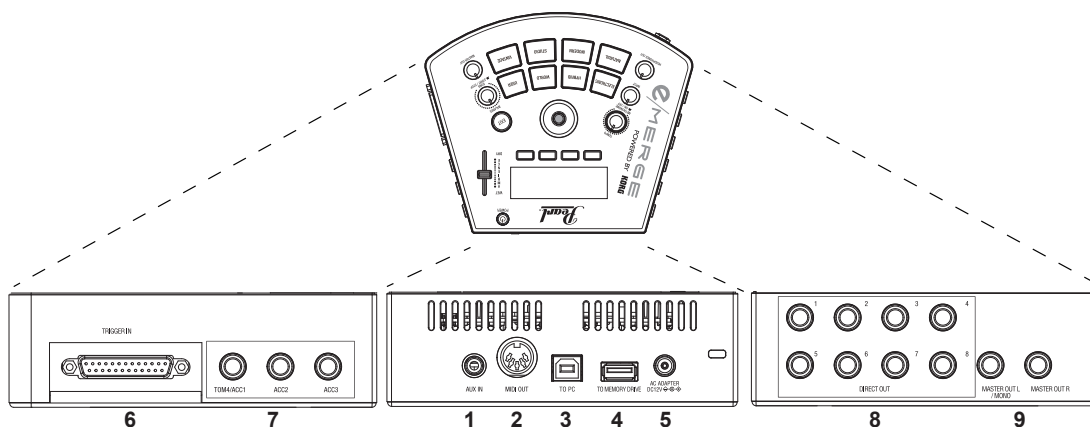

1. AUX IN jack

Use these jacks to connect to an audio player or other external audio output device.

2. MIDI OUT connector

Use this to connect to an external sound generator or other MIDI device (→ p.11 “Connecting to a computer or MIDI device”).

3. TO PC port (USB-B)

Connect the module to your computer with a USB cable to transmit and receive USB MIDI, and to receive USB audio data (→ p.11 “Connecting to a computer or MIDI device”).

4. TO MEMORY DRIVE port (USB-A)

Connect a USB flash drive here. WAV files and setting data can be read and written to the flash drive.

5. DC 12V jack

Caution: Only connect the power supply included with the e/MERGE module. Never use any other power supply; doing so will damage the module and void the Warranty.

6. TRIGGER IN connector

Attach the included breakout cable to connect each pad.

7. ACC IN (TOM4/ACC1, ACC2, ACC3) jacks

Connect a 6.3 mm TRS phone plug cable to add more pads.

Note: Connect to the TOM4/ACC1 to add more tom pads.

8. DIRECT OUT 1–8 jacks

Connect these jacks to a mixer or other device to send the sound of each pad (module), to output the playback sound of a song and so on.

Note: The sound from the DIRECT OUT jacks will not be routed to the MASTER OUT jacks.

9. MASTER OUT L/MONO, R jacks

Connect these jacks to a powered monitor, stereo amp or mixer. If you’re using a monaural connection, connect to the L/MONO jack.

Preparations

Settings

Cautions during connection

- Before connecting this module to the pads, place this module on a rack or stand.
- Use the dedicated breakout cable that is included, in order to connect the module to the PureTouch Pad.
- Connect the additional pads 1/2/3 to the ACC IN (TOM4/ACC1, ACC2, ACC3) jacks on the module using the cables included with the additional pads (optional).
- Make sure that the cable is long enough when connecting.
- Arrange the cables so that they do not get pinched by the pedal or stand.

Steps for connecting

1. **Mount each pad and the module on the rack.**
Refer to “How to Assemble”(a separate sheet).
2. **Connect the included breakout cable to the module.**
3. **Connect each cable coming from the breakout cable to each pad.**
While checking the marker on each cable, connect each pad carefully without getting the connections mixed up.

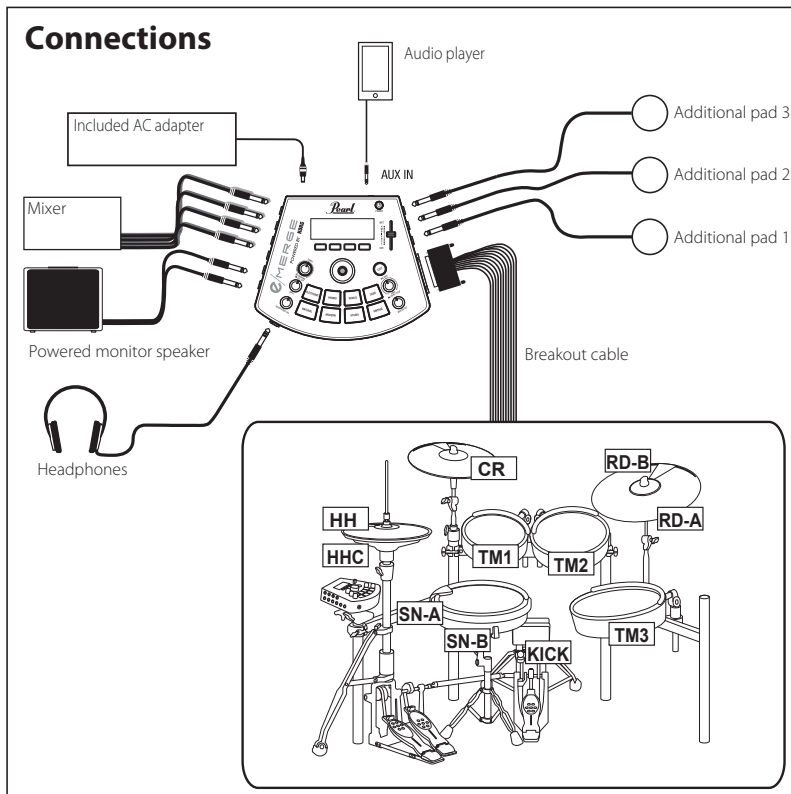

 The cable marked "KICK" that is connected to the KICK (kick drum) supplies the power used for lighting the LED. When connecting this cable to other products besides the specified pad, set Trigger Type to "OTHER" beforehand, and be sure to turn off the power before connecting. Use caution, as the unit may malfunction if you make the wrong settings. (→ p.40 "TRIGGER PAD")

 The cable marked "HHC" that is connected to the hi-hat is only to be used for the EM-14HH, and supplies power for the sensor. Do not connect the cable marked "HHC" to any other products besides the specified pad. Use caution, as making the incorrect connection may cause the unit to malfunction.

4. Connect the included AC adapter, a powered monitor speaker, stereo amp, or mixer to this module.

(→ p.10 "Connecting the included AC adapter")

(→ p.10 "Connecting audio devices")

Note: When assembling this drum set for the first time or reassembling it, calibrate the hi-hat. (→ p.42 "HI-HAT CALIBRATION")

Connecting the included AC adapter

Fully insert the power cord for the AC adapter into the AC adapter, and then insert the DC plug into DC 12V jack on the rear panel.

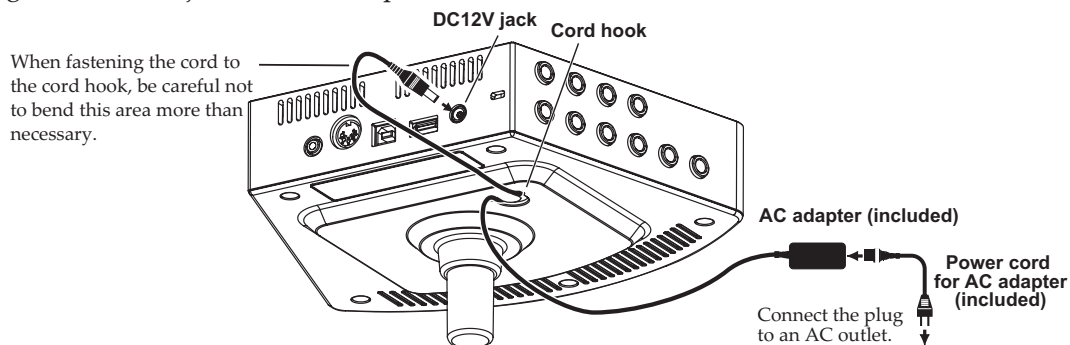

- ⚠ Make sure to secure the AC adapter cord to the cord hook on the bottom panel, to make it harder for the DC plug to accidentally disconnect.
- ⚠ Use only the included AC adapter. Using a different AC adapter may cause a malfunction.

Connecting audio devices

- ⚠ Turn off your devices before making connections. If you leave the power on when making connections, your devices or speakers might be damaged.

Connecting to a powered monitor speaker or mixer

Connect the input jacks of your powered monitor speaker or mixer to the MASTER OUT L/MONO, R jacks of this module.

To output the sound for each pad separately or to add an external effect, connect using the DIRECT OUT 1–8 jacks.

If you want to monitor the sound through headphones, connect your headphones to the  (Headphones) jack on this module. Use the HEADPHONES OUT knob to adjust the headphone volume.

Note: The volume may seem a little low if you are listening with headphones of 80Ω impedance or more.

Connecting an audio player to the AUX IN jack

Use the AUX IN jack to connect an external audio output device such as an audio player.

When connecting a mic to this module, connect the mic amp and mixer first.

Use the INPUT knob to adjust the input level.

Connecting to a computer or MIDI device

Connecting to a computer

Connect the To PC port on this module to your computer using a USB 2.0 cable (sold separately) to exchange MIDI message data. This port can also receive audio data.

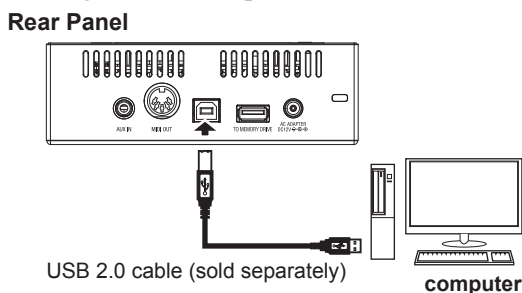

You can connect the e/MERGE to a computer, in order to control software sound sources and so on.

Note: For audio, this instrument uses the standard USB audio driver that comes with Windows or macOS, so you don't need to install the audio driver separately.

Connecting a MIDI device

Connect the MIDI OUT connector of the e/MERGE to the MIDI IN connector of an external MIDI device and use the pads of this instrument to play the external MIDI device.

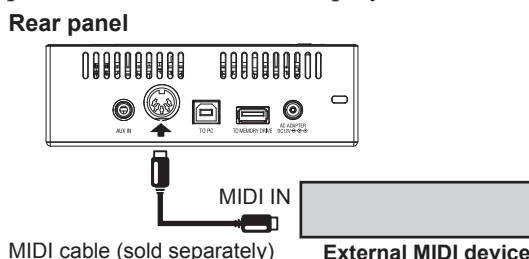

Connecting a USB flash drive

Connect a commercially-available USB flash drive to the TO MEMORY DRIVE port on this module.

Make sure to format the USB flash drive on this module before use. (→ p.57 "USB MEMORY FORMAT")

Note: A USB flash drive of up to 2 TB in size can be used. Some USB flash drives may not work with the e/MERGE.

 Some USB flash drives may heat up when rapidly accessing memory.

Turning the power on and off

Turning the power on

1. Turn the MASTER OUT and HEADPHONES OUT knobs all the way to the left, so that the volume is at a minimum.
2. Make sure that the volume on any external devices that are connected (such as powered monitor speakers or mixers) is turned down and that the power is turned off.
3. Keep holding the power button on this module down until the display lights up. The drum kit name will be shown on the display.

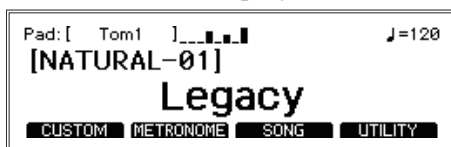

Tip: The name of the drum kit last used before the power was turned off will be shown.

4. Turn on the power of the external equipment.
Turn on the power of the external equipment connected to the output jacks of this module (MASTER OUT L/MONO, R, DIRECT OUT 1–8), including powered monitor speakers, mixer amps and so on.
 5. Adjust the volume.
Adjust the MASTER OUT knob on this module and the volume on your external equipment to set the volume to a suitable level.
-  Operating the MASTER OUT knob will not change the volume of sound coming from DIRECT OUT 1–8.

Turning the power off

Note: When a set period of time has passed without playing the pads, turning the knobs or pressing the buttons on this module, the power will automatically turn off. You can also set this module so that the power does not automatically turn off. (→ p.55 “AUTO POWER OFF”)

1. Turn the volume all the way down on any external output devices that are connected.
Lower the volume on the external output devices connected to this module, and then turn off the power.
 2. Turn the MASTER OUT and HEADPHONES OUT knobs all the way to the left, so that the volume is at a minimum.
 3. Keep holding the power button on this module down until the display goes dark. Once the display goes dark, the power will turn off.
-  Do not remove the AC adapter or the power cord before the display goes dark. Failure to do so may cause a malfunction.

Changing the drum kits

There are 35 preset drum kits on the Pearl e/MERGE separated into seven categories, and 50 user drum kits can be saved.

The **preset drum kits** cannot be overwritten. The **user drum kits** can be adjusted to match your tastes and then saved.

Tip: The user category drum kits contain the same drum kits as the preset category drum kits when initially shipped from the factory.

1. Pressing a category button will let you select a drum kit within that category.

Pressing the same category button again will switch to the next drum kit in that category.

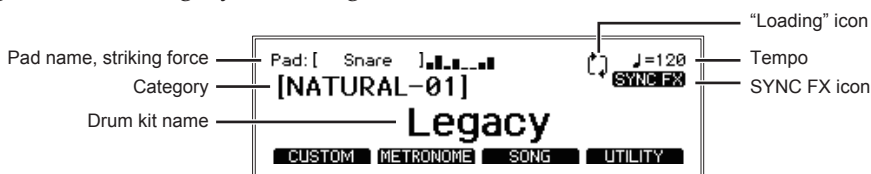

Tip: The pad that you strike and the strength of your stroke is displayed on the top left of the top page. Use this information to make sure that your connections are correct.

Tip: If BPM synchronization can be done with the MFX, the SYNC FX icon will be displayed. (→ p.75 "MFX Type List")

Note: Data will be loaded when the drum kit is changed. The "⌂" icon will appear on the display while data is being loaded. The pads may not make any sound if they are struck while the "⌂" icon is displayed.

2. Select a drum kit by turning the dial.

Turning the dial will let you select a drum kit within all categories.

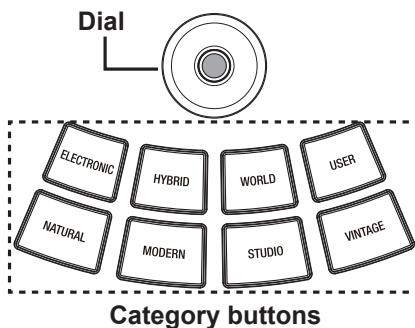

Configuration Guide

CUSTOM: Drum Kit User Edit

When you want to create your own drum kit, select an existing preset drum kit that is closest to the kit you have in mind, and then edit it. Use this function to select the pads for the drum kit you wish to create, after which you can select the instruments assigned, levels, and tuning. This is called “**user edit**.”

The preset drum kits on this module can be edited, but they cannot be overwritten.

For this reason, you will need to edit and create your own original drum kit, and then save it to a user category.

Displaying and editing using the edit menu

1. Select the preset drum kit to edit. (→ p.13 “Changing the drum kits”)
2. Press the [CUSTOM] function button shown on the top page to display the CUSTOM menu.

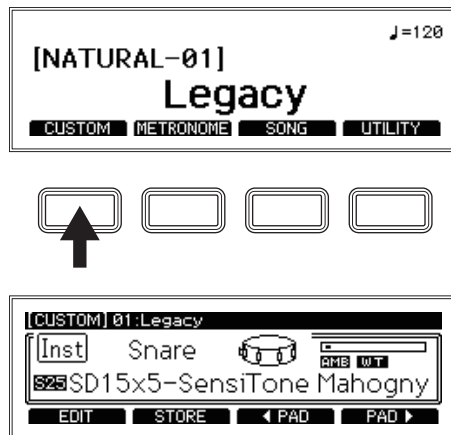

3. Select the pad to edit.

Select the pad to modify by either striking it or by using the [◀ PAD][PAD ▶] (pad selection) function buttons.

4. Change the pad's instrument.



Use the dial to change the instrument assigned to the pad.

Tip: To mute a pad so that it makes no sound when you strike it, turn the dial all the way to the left to the OFF setting.

Tip: Refer to the “Inst List” (→ p.68) for a list of the instruments that can be selected on each pad.

Tip: The Inst properties icon will light up when you have selected an instrument (Inst) on which the respective functions are enabled.

Icon	Explanation
AMB	The AMBIENCE can be controlled on this instrument.
WT	The instrument supports WAVE Trigger Technology.
O-C	The instrument allows the hi-hat open/close sounds to be controlled with the hi-hat pedal.
ANY	The instrument can be assigned to any pad.

5. To store your changes to an Inst, press the [STORE] function button.

(→ p.16 “Storing a drum kit”)

To cancel editing a drum kit, press the EXIT button.

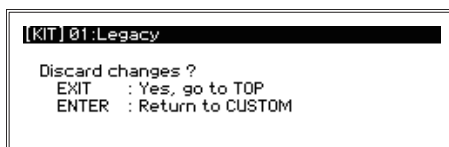

Press the EXIT button once more to cancel editing and return to the top page.

To continue editing, press the ENTER button to return to “CUSTOM” menu.



To make detailed settings, press the [EDIT] function button to display the parameter edit menu for the drum kit. (→ p.17 “Editing the detailed parameters”)

Tip: When you have made changes to the “CUSTOM” menu or edit menu values, press the CATEGORY button. This will display a screen which asks you to return to the top page or to the “CUSTOM” menu, in the same way as pressing the EXIT button. If you have not changed any values, you will return to the top page of the category you pressed.

Storing a drum kit

1. Press the [STORE] function button on the “CUSTOM” menu.



2. Use the dial to select the store destination.



- **Kit Name**
The name of the currently selected drum kit will be displayed. Press the [RENAME] function button to change the drum kit name. (→ p.16 “Renaming”)
- **Destination** **01...50**
Using the dial, select the number of the user drum kit to which you want to store.

3. Press the [RENAME] function button to change a drum kit name.

Renaming

The screenshot shows a menu titled "[KIT] 01:Legacy". Below the title, it displays "Legacy" with a cursor under the 'y'. At the bottom, there are four buttons: "A/a/0/!", "DELETE", "INSERT", and "ENTRY".

1. **Select the character in the name to change using the dial, and press the ENTER button.**
2. **Select a character using the dial.**
Use the [A/a/0/!] function button to jump to the first character within each character set.
Press the [DELETE] function button to delete the selected character.
Press the [INSERT] function button to insert a character (space) at the location of the currently selected character.
To confirm your changes, press the ENTER button.
3. **To change other characters, repeat steps 1 and 2.**
4. **Press the [ENTRY] function button to finish renaming the kit.**
This will complete the renaming operation, and the display will return to the previous screen. To cancel, press the EXIT button.

5. Press the [STORE] function button.



When you press the [STORE] function button, a message will be displayed asking if you are sure.

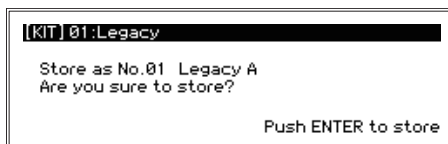

Press the EXIT button at this time if you want to cancel storing.

6. Press the ENTER button to store.

Editing the detailed parameters

1. To edit the detailed parameters, press the [EDIT] function button in the CUSTOM menu.

The parameter edit menu will be displayed, and detailed parameters regarding the drum kit will be shown.



2. Use the dial to move to the parameter you want to edit.

The ">>" mark will be displayed next to the selected parameter.



3. Press the ENTER button to move to the value.

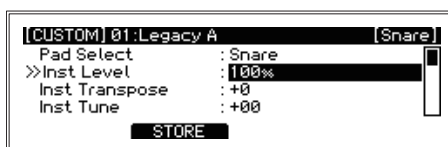

Tip: When selecting the Comp Edit, EQ Edit and MFX Edit parameters, more edit pages will be displayed.

4. Turn the dial to change the value.

5. Press the ENTER button to confirm your change.

Repeat steps 2, 3 and 4 to continue editing other parameters.

To cancel editing and revert the settings to their previous state, press the EXIT button. The values will be restored, and the cursor will move to the parameter selection.

Tip: Press the [ENTRY] function button to confirm the changes you made to the Comp Edit, EQ Edit and MFX Edit parameters. The settings will be confirmed, and the display will return to the edit menu.

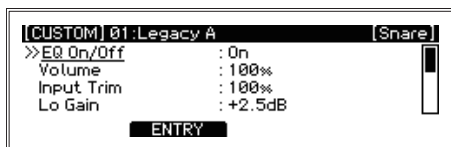

6. Press the [STORE] function button to save all of the parameters you edited.



7. Use the dial to select the save destination and begin saving.

(→ p.16 “Storing a drum kit”)

Tip: The settings you make will depend on the type of parameter used. The steps used to set some parameters may differ.

Note: Depending on the parameter, increasing these values may cause distortion or noise.

Drum kit parameter edit menu



The parameters that can be edited using the drum kit parameter edit menu are shown below.

Note: Depending on the parameter, increasing this value may cause distortion or noise.

Pad Select

Sets the pad to edit.

Selectable pads:

Snare, Tom1, Tom1Rim, Tom2, Tom2Rim, Tom3, Tom3Rim, Kick, Hi-Hat, Crash, Ride, Tom4/Acc1, Acc2, Acc3

Inst Level.....000...200%

Sets the volume of the instruments for the currently selected pad.

Inst Transpose -12...+12

Adjusts the pitch of the currently selected pad in semitones.

Note: This parameter may not have an effect in certain ranges for certain instruments.

Inst Tune-100...+100

Adjusts the pitch of the currently selected pad in cents.

Inst Decay.....-100...+100

Sets the decay time (the length of time it takes for the sound to fade out) for the currently selected pad.

Note: This parameter may not have an effect in certain ranges for certain instruments.

Inst Pan.....-50(L)...0(CNT)...+50(R)

Sets the panning position (the left-right volume balance) for the currently selected pad.

Comp Edit

Sets the COMP (compressor) parameters for the currently selected pad. To access the parameters below, select "Comp Edit" using the dial and then press the ENTER button.

Compression is the process of decreasing the dynamic range between the loudest and quietest parts of an audio signal. This process is done by boosting the quieter signals and attenuating the louder signals.

The solid line in the above chart shows, when the input signal is larger than the internal

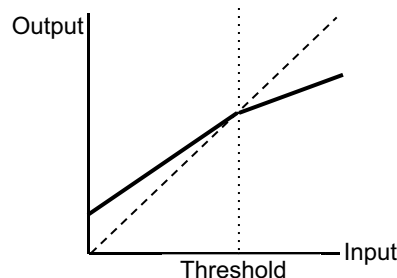

threshold, the output is small. When the signal is smaller than the threshold, the output is increased.

Using compression creates the effects listed below.

- Averaging volume: Averaging the dispersed volume to make it easy to listen.
- Increase sound pressure: When a quiet sound gets louder, it increases volume. (sound pressure)
- Emphasizing the attack: Setting the time for the compressor to increase the attack.
- Emphasize the sustain: Increasing the volume of damping sound reverberation to emphasize sustain.

It is a very popular effect that can be difficult to implement. When used incorrectly, it eliminates the nuance and produces an unnatural sustained sound. On the other hand, you can apply the effect intentionally to create unusual sounds and effects.

- **Comp On/Off**..... **Off, On**
Enables/disables the COMP effect.
- **Sens** **000...100**
Adjusts the sensitivity of the COMP.
Increasing this value will reduce the output of a loud sound and increase the output of a weak sound.
- **Attack** **000...100**
Adjusts the attack time of the COMP.
The Attack setting controls how long the compressor takes to compress the signal. When it is set low, the compression begins immediately. When the attack is increased, it will take longer for the compression to engage.
- **Level** **000...100**
Adjusts the output level of the COMP.
After you apply compression to the instrument, the volume may need to be adjusted to balance the sound with the rest of the kit.

EQ Edit

Sets the EQ (equalizer) parameters for the currently selected pad. To access the parameters below, select “EQ Edit” using the dial and then press the ENTER button.

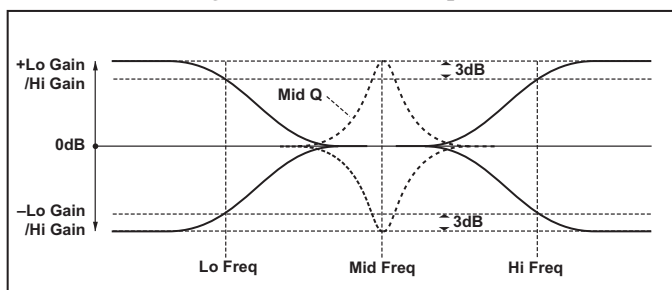

The following chart shows the EQ signal flow.

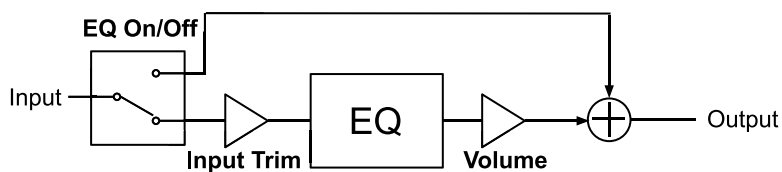

The EQ consists of three bands labeled Lo, Mid, and Hi.

• Lo(Low)

Set the LO Freq around 60-300Hz. It is a shelving type that can cut or boost the components lower than shown in the chart below.

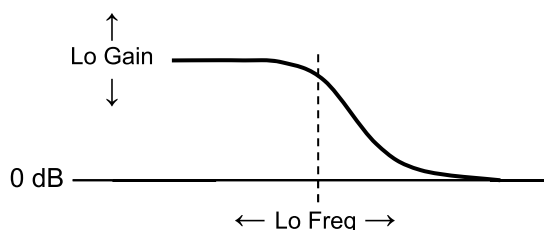

*This chart shows an example of a boost being applied.

Use this option to cut unnecessary low frequencies, or to emphasize the low frequencies and increase sound pressure.

• Mid

Mid Freq is set around 250-3000Hz normally. Since it is peaking type, cut, or boost centering on the frequencies shown on the Mid Q chart below.

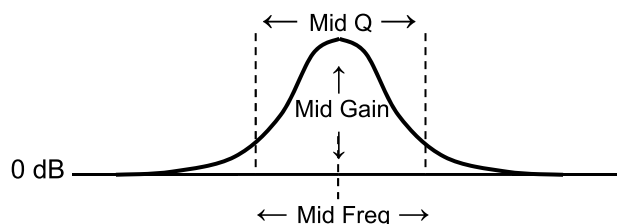

*This chart shows an example of a boost being applied.

This parameter can be used for many purposes, such as emphasizing the low frequencies

to make a thick sound with strong attack or to decrease unwanted sound, and emphasize interval for toms, etc.

• **Hi(High)**

Set Hi Freq higher than 3000Hz basically. It is a shelving type, cut or boost the components higher than set frequencies shown in the chart below.

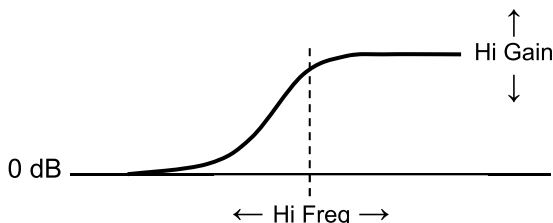

*This chart shows an example of a boost being applied.

This parameter can be used for many purposes, such as emphasizing the low frequencies to make a thick sound with a strong attack or to decrease unwanted sound, and emphasize interval for toms, etc.

- **EQ On/Off** **Off, On**
Enables/disables the EQ effect.
- **Volume** **0...200% (in units of 2%)**
Adjusts the EQ output level.
Depending on the EQ setting, the output volume might change. Adjust this parameter to make the proper volume.
- **Input Trim** **000...100%**
Adjusts the input level going into the EQ.
Depending on the EQ setting, the sound might be distorted. Adjust this parameter to make the proper level.
- **Lo Gain** **-18dB ... +18dB (in units of 0.5 dB)**
Adjusts the low end EQ frequency band upwards or downwards.
- **Lo Freq** **60...15400Hz**
Sets the frequency band for which the low end EQ is adjusted.
- **Mid Gain** **-18dB ... +18dB (in units of 0.5 dB)**
Adjusts specific EQ frequency bands upwards or downwards.
- **Mid Freq** **60...15400Hz**
Sets the specific frequency band on which the EQ is adjusted.
- **Mid Q** **0.5...10 (in units of 0.1)**
Adjusts the frequency range that will be affected when adjusting a specific EQ band.
- **Hi Gain** **-18dB ... +18dB (in units of 0.5 dB)**
Adjusts the high end EQ frequency band upwards or downwards.
- **Hi Freq** **60...15400Hz**
Sets the frequency band for which the high end EQ is adjusted.

Inst Amb Max Level 000...100

Adjusts the ambience level when the AMBIENCE fader for the currently selected pad is set to maximum. Adjust this when you want to keep the maximum ambience levels down for a specific instrument.

Note: The ambience effect has no effect on some instruments.

Note: This will have no effect if it is not set to a higher value than the Inst Amb Min Level.

Inst Amb Min Level..... 000...100

Adjusts the ambience level when the AMBIENCE fader is set to minimum for the currently selected pad. Adjust this when you want to hear an ambience effect for a specific instrument, even when the AMBIENCE fader is set to minimum.

Note: The ambience effect has no effect on some instruments.

KIT PARAMETERS

Kit Level 000...100

Adjusts the volume for the entire drum kit.

Kit Amb Level..... 000...100

Adjusts the ambience level for the drum kit.

As with the AMBIENCE fader, this value determines the default value when a drum kit is selected. Operating the AMBIENCE fader will cancel this value and give priority to the fader state.

Mic Distance 0m, 3m, 6m, 9m, 18m

Adjusts the distance of the ambience mic.

MFX Type

Selects the master effect (→ p.75 “MFX Type List”).

MFX Edit

When MFX Edit is selected, press the ENTER button to go to the edit page for the currently selected MFX parameter.

Refer to the “MFX Type List” (→ p.75) for details on the MFX parameter edit page.

[METRONOME] Metronome function

You can save settings as a **metronome project** to meet specific needs, so that you can start playing right away. Fifty different settings can be saved and selected as necessary for use.

Using metronome

The metronome will start and stop with each press of the TEMPO knob (METRONOME ON/OFF).

Use the TEMPO knob to adjust the tempo.

Adjust the volume using the INPUT knob.

Note: You will not be able to hear the metronome sound when the INPUT knob is turned all the way down.

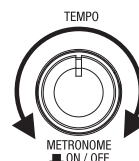

Detailed metronome settings

You can set the time signature, metronome sound and volume in the METRONOME menu.

1. Press the [METRONOME] function button shown on the top page.

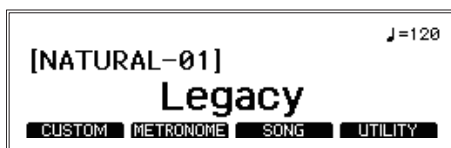

2. Use the dial to select the parameter you want to edit.

The “>>” mark will be displayed next to the selected parameter.



- **Tempo.....30...300**

Use these buttons to set the metronome tempo. To adjust the tempo while listening to a song, press the TEMPO knob (METRONOME ON/OFF) to make the tempo sound start (the LED on the METRONOME ON/OFF button will blink in time with the tempo).

When the UTILITY-MIDI “Clock In” setting is set to “External” (USB-MIDI only), the tempo follows the tempo clocks sent from the application running on the computer or other device (→ p.46 “MIDI”).

Tip: When this is set to “External”, “EXT” will be displayed for the tempo value on the top right corner of the top page.

- **Time Signature 1/2...24/2, 1/4...24/4, 1/8...24/8, 1/8t...24/8t, 1/16...24/16**

Sets the time signature.

- **Sound** (all 10 sounds)
Sets the metronome sound. (→ p.76 “Metronome sound list”).
- **Level**.....0...100(unity)...200
Sets the metronome volume level.
- **[TAP] function button**
Use these settings to set the tempo at the interval with which you push the [TAP] function button, regardless of whether the metronome is on or off.
- **[STORE] function button**
Press the [STORE] function button to confirm the changes you made to the parameters of the project.
- **[LIST] function button**
Switches between the metronome project selection and edit screens.
(→ p.26 “Selecting a metronome project”)

3. Press the ENTER button to move to the value.

Turn the dial to change the value. Press the ENTER button to confirm your change. To stop editing and revert to the previous settings, press the EXIT button. However, when the power is turned off, the default settings will be restored.

Storing a metronome project

1. Press the [STORE] function button on the “METRONOME” menu.



2. Use the dial to select the store destination.

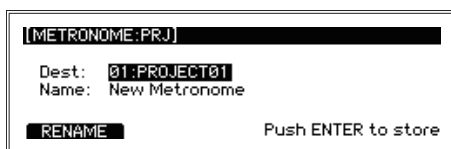

- **Dest.** 01...50
Using the dial, select the number of the metronome project to which you want to store.
- **Name**
The name of the currently selected metronome project will be displayed. Press the [RENAME] function button to change the metronome project name. (→ p.16 "Renaming")

3. Press the ENTER button to store.

Press the EXIT button at this time if you want to cancel storing.

Selecting a metronome project

Select from the list of saved metronome projects.

1. Press the [LIST] function button.

[METRONOME:LIST]			
	Tempo	TimeS	Level
01 PROJECT01	: 120	4/4	100
02 PROJECT02	: 100	2/4	100
03 PROJECT03	: 120	4/4	100
04 PROJECT04	: 120	4/4	100

EDIT COPY MOVE DELETE

2. Select a metronome project using the dial.

The selected project will display in inverse color.

[METRONOME:LIST]			
	Tempo	TimeS	Level
01 PROJECT01	: 120	4/4	100
02 PROJECT02	: 100	2/4	100
03 PROJECT03	: 120	4/4	100
04 PROJECT04	: 120	4/4	100

EDIT COPY MOVE DELETE

3. Press the ENTER button.

The settings of the selected metronome project will be reflected.

Editing a metronome project

You can select a metronome project from the list, change and then save the settings. By saving the settings you use most often, you will be able to select them from the list and quickly change the metronome settings.

1. Press the [LIST] function button.

[METRONOME:LIST]			
	Tempo	TimeS	Level
01 PROJECT01	: 120	4/4	100
02 PROJECT02	: 120	4/4	100
03 PROJECT03	: 120	4/4	100
04 PROJECT04	: 120	4/4	100

EDIT COPY MOVE DELETE

2. Select the metronome project that you want to edit using the dial.

The selected project will display in inverse color.

[METRONOME:LIST]			
	Tempo	TimeS	Level
01 PROJECT01	: 120	4/4	100
02 PROJECT02	: 120	4/4	100
03 PROJECT03	: 120	4/4	100
04 PROJECT04	: 120	4/4	100

EDIT COPY MOVE DELETE

Metronome project list screen operations

Press the [METRONOME] and then the [LIST] function button to display the metronome project list.

[METRONOME:LIST]			
	Tempo	TimeS	Level
01 PROJECT01	: 120	4/4	100
02 PROJECT02	: 120	4/4	100
03 PROJECT03	: 120	4/4	100
04 PROJECT04	: 120	4/4	100

EDIT COPY MOVE DELETE

There are 50 metronome projects.

Four functions are assigned to the function buttons, [EDIT], [COPY], [MOVE] and [DELETE].

- **[EDIT] function button**

This lets you make detailed settings for the currently selected metronome project. (→ p.29 “Metronome parameter edit menu”)

- **[COPY] function button**

Copies the currently selected metronome project to a specified metronome project number.

Select the metronome project number copy destination using the dial, and press the ENTER button to copy.

The display will return to the currently selected metronome project after copying is finished.

- **[MOVE] function button**

Moves the currently selected metronome project to a specified metronome project number. After this is done, the display will change to the specified metronome project.

- **[DELETE] function button**

Deletes the currently selected metronome project (returns the metronome project to the default state).

3. Press the [EDIT] function button.



4. Use the dial to select the parameter you want to edit.

Press the ENTER button to move to the value.

Turn the dial to change the setting.

Press the ENTER button to confirm your change. (→ p.29 “Metronome parameter edit menu”)



5. Press the [STORE] function button to confirm the changes you made to the parameters of the project.

To stop editing and revert to the previous settings, press the EXIT button.

Metronome parameter edit menu



- **Name**
Sets the name of the metronome project that you are editing (up to 24 characters).
(→ p.16 "Renaming")
- **Tempo**.....030...300
Sets the tempo for each metronome project.
- **Time Signature** 1/2...24/2, 1/4...24/4, 1/8...24/8, 1/8t...24/8t, 1/16...24/16
Sets the time signature for each metronome project.
- **Sound**all 10 sounds
Sets the metronome sound for each metronome project. (→ p.76 "Metronome sound list").
- **Level**.....0...100(unity)...200
Sets the volume level for each metronome project.

[STORE] function button

Stores the metronome project that you created.

[SONG] Song function

Two WAV file tracks (a **music track** and a **click track**) can be played in sync on this module from a USB flash drive.

The combination of output levels for music and click tracks is called a **song project**. Song projects are managed in the song project list.

Registering a WAV file in a song project

To use a song, connect a commercially available USB flash drive to the TO MEMORY DRIVE port.

Tip: The warning, “Please connect your USB Drive” will display if a USB flash drive is not inserted.

1. **Connect a USB flash drive that contains WAV files, into the TO MEMORY DRIVE port.** Use your computer to save WAV files to a commercially available USB flash drive.

 You must format commercially available USB flash drives on this module before using it. (→ p.57 “USB MEMORY FORMAT”)

Tip: WAV files to be used in song projects must be located in the root directory of the USB flash drive.

Tip: The specs for files that can be loaded into the e/MERGE are as follows:

- WAV files (PCM format)
- Sampling frequency: 44.1 kHz
- Bit length: 16 bits
- Maximum 4 hours (stereo/mono)

2. Press the [SONG] function button shown on the top page to display the SONG menu.

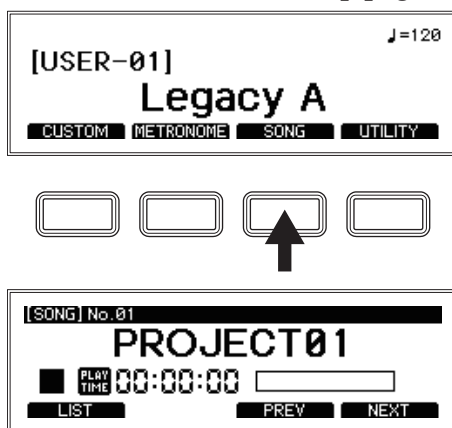

3. Press the [LIST] function button.

Fifty song projects will be displayed in the list.

You will need to edit one of these song projects made available in order to use them (→ p.33 “Song project list screen operations”).

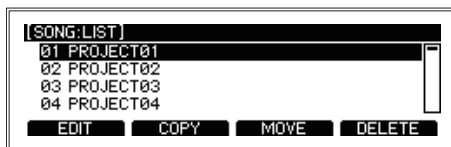

4. Select the song project from the song project list.

The selected project will display in inverse color.

5. Press the [EDIT] function button.

Information that is set for the song project will be shown. (→ p.34 “Song parameter edit menu”)

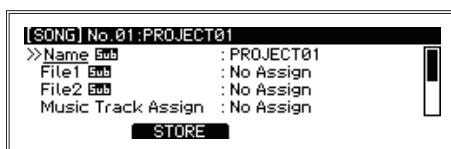

6. Select the File1 item, and press the ENTER button.

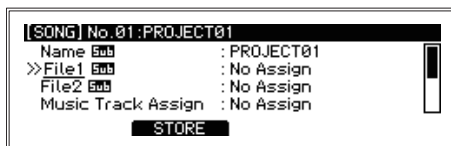

The WAV files saved on the USB flash drive will be shown.

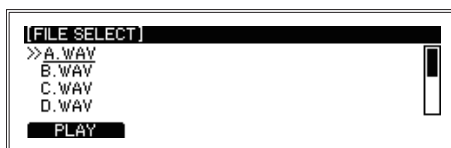

7. Select the file that contains the data you wish to load into the music track, and press the ENTER button.



8. In the same way, select the File2 item and select the file that contains the data you wish to load into the click track.

 The click track sound will not be routed to the MASTER OUT L/MONO, R jacks. The click sound will be routed to the  (Headphones) jack so that you can monitor it.

Tip: The music track and click track can also be sent as separate sounds from the DIRECT OUT jacks. (→ p.45 “DIRECT OUT”)

9. Press the [STORE] function button to save the song project to USB flash drive.

The display will return to the song project list.

Selecting and playing back a song project

1. Press the [SONG] function button shown on the top page to display the SONG menu. After entering the SONG menu, use the [PREV] and [NEXT] function buttons to select a song project.



Tip: You can also press the [LIST] function button to select from the song project list. (→ p.33 “Song project list screen operations”)

2. Pressing the SONG START/STOP button will alternate between starting and stopping the song.



You can change the playback position with the dial.

Turn the dial to the right to fast-forward. You can fast-forward in increments of 1 second during playback, or 10 seconds when stopped.

Turn the dial to the left to rewind. You can rewind in increments of 1 second during playback, or 10 seconds when stopped.

Use the BALANCE knob to adjust the volume balance between the music track and the click track.

Refer to the “BALANCE knob, SONG START/STOP button” (→ p.6)

- **[LIST] function button**

Displays the song project list.

Song project list screen operations

Press the [SONG] and then the [LIST] function button to display the song project list.

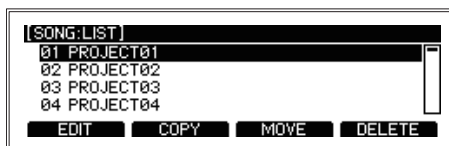

There are 50 song projects.

Four functions are assigned to the function buttons, [EDIT], [COPY], [MOVE] and [DELETE].

- **[EDIT] function button**

This lets you make detailed settings for the currently selected song project. (→ p.34 “Song parameter edit menu”)

- **[COPY] function button**

Copies the currently selected song project to a specified song project number. Select the song project number copy destination using the dial, and press the ENTER button to copy.

The display will return to the currently selected song project after copying is finished.

- **[MOVE] function button**

Moves the currently selected song project to a specified song project number. After this is done, the display will change to the specified song project.

- **[DELETE] function button**

Deletes the currently selected song project (returns the song project to the default state).

- **[PLAY]/[STOP] function button**

Plays back song project stored on a USB flash drive.

When this module is in SONG mode, this button switches between PLAY and STOP for the currently selected song.

- **[PREV] function button**

Switches to the previous song project. Pressing this button during playback or while the song project is paused will return to the top of the song that was being played back.

- **[NEXT] function button**

Switches to the next song project.

Song parameter edit menu

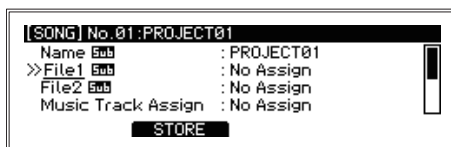

- **Name**
Displays the song project name. Press the ENTER button to rename the song project.
(→ p.16 “Renaming”)
- **File1**
Select File1 using the dial and press the ENTER button. The WAV file list will be displayed. Select a WAV file using the dial.
Select “No Assign” if you do not wish to assign a file to File1.
- **File2**
Select File2 using the dial and press the ENTER button. The WAV file list will be displayed. Select a WAV file using the dial.
Select “No Assign” if you do not wish to assign a file to File2.
- **Music Track Assign No Assign, File1 LR, File2 LR, File1 L, File1 R, File2 L, File2 R**
Select the output source for the music track using the dial.
- **Music Track Level 000...100(unity)...200**
Use the dial to set the volume for the music track.
- **Click Track Assign No Assign, File1 LR, File2 LR, File1 L, File1 R, File2 L, File2 R**
Select the output source for the click track using the dial.
- **Click Track Level 000...100(unity)...200**
Use the dial to set the volume for the click track.
- **Loop PlayOff, On**
Set whether to repeatedly play back a song project.

[STORE] function button

The various settings for the song project will be stored.

[UTILITY] Other functions and settings

The UTILITY menu of the e/MERGE module contains many functions and settings.

Selecting a function

1. Press the [UTILITY] function button shown on the top page to display the UTILITY menu.

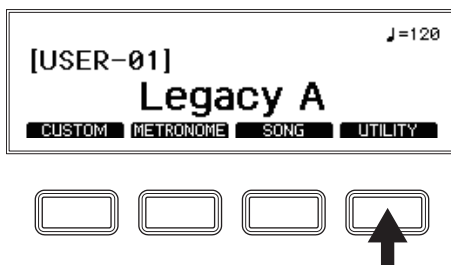

2. Use the dial to select the function, and press the ENTER button to confirm.

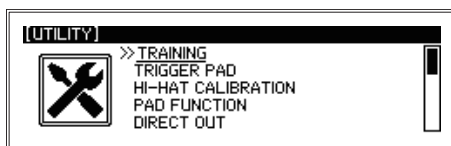

Select the utility to execute using the dial. Press the ENTER button to view the setting screens for each utility.

For the functions and settings, use the four function buttons, the dial and the ENTER button, as with other menu settings.

Utilities

TRAINING

The training function lets you play along with WAV files saved to USB flash drive, or with music sent from the AUX IN jack or from USB audio. Your playing is recorded to internal memory, so that you can play it back to check how you did.

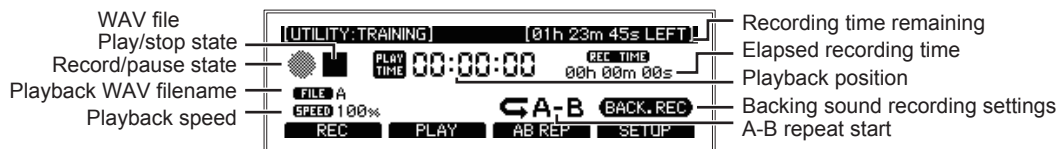

Recording while playing back a WAV file

1. Connect a USB flash drive that contains WAV files, into the TO MEMORY DRIVE port. Use your computer to save WAV files to a commercially available USB flash drive.

⚠ You must format commercially available USB flash drives on this module before using it. (→ p.57 "USB MEMORY FORMAT")

Tip: WAV files to be used in song projects must be located in the root directory of the USB flash drive.

Tip: The specs for files that can be loaded into the e/MERGE are as follows:

- WAV files (PCM format)
- Sampling frequency: 44.1 kHz
- Bit length: 16 bits
- Maximum 4 hours (stereo/mono)

2. Press the [UTILITY] function button shown on the top page to show the “UTILITY” menu.

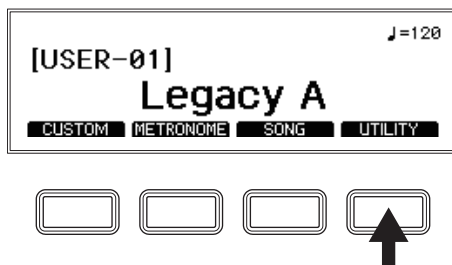

3. Select “TRAINING” using the dial, and press the ENTER button to confirm.

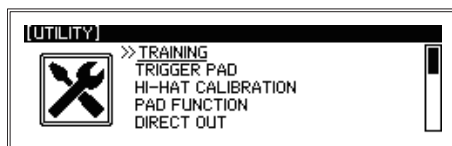

4. Press the [SETUP] function button on the TRAINING page.

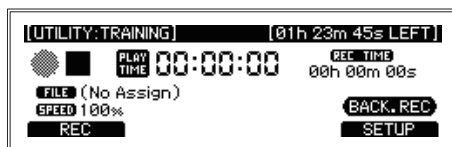

The SETUP page will appear.

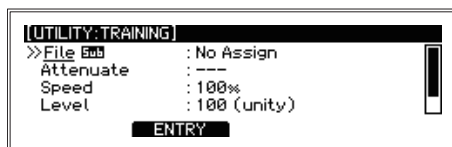

5. Sets the WAV file to play back.

Set the WAV file to play back in “File.”

• **File**

Displays the name of the currently selected WAV file.

Use the dial to select either “External Drive” (USB flash drive) or “Internal Drive” (internal memory), and press the ENTER button to confirm.

The WAV file that was recorded will be saved to internal memory.

Use the dial to select a file on the FILE SELECT page.



Select "No Assign" if you do not want to specify a file.

Use the [PLAY]/[STOP] function button to preview or stop playback of the currently selected WAV file.

When a file on the internal drive is selected, you can press the [EXPORT] and [DELETE] function buttons to store the currently selected file to a USB flash drive, or to delete it from the internal drive.

Press the ENTER button to confirm your selection of the WAV file.

Note: When deleting a file, if the WAV file you selected has already been set as a WAV file for playback, "Already assigned" will be displayed and you will not be able to delete the file. To delete the file, change the file settings and then delete it.

• **Attenuate** **Off, On**

Sets whether the playback level of WAV files on a USB flash drive will be attenuated.

On: When playing the drum kit while playing back WAV files containing music and so on, set the WAV file playback volume to "On" (attenuation enabled) to achieve the appropriate volume.

Off: When saving files in internal memory that were recorded using the training function of this instrument (Internal Rec File) to a USB flash drive and playing the files back from the flash drive, set this to "Off" (attenuation disabled).

Note: When this parameter is set to "Off", the playback level will remain the same and will not fade out. For this reason, WAV files recorded using other devices may sound distorted, depending on the file.

• **Speed** **50%...200%**

Sets the playback speed of the training file.

• **Level** **0...100(Unity)...200**

Sets the volume level of the training file.

• **Backing Rec** **Off, On**

When you want to play in training mode to a backing sound (via the AUX-IN jack, USB audio, a song playback sound or the sound of the metronome), this sets whether the backing sound is also recorded.

6. **Press the [ENTRY] function button on the "SETUP" page.**

Confirms what you have edited, and returns to the TRAINING page.

Press the EXIT button to cancel the various settings and return to the TRAINING page.

7. Play back the WAV file, and practice playing the drums.

You can play back WAV files at different speeds, or loop the playback of certain parts to practice with them.



Tip: The [PLAY] and [AB REP] function buttons shown below will only be shown if a WAV file is selected in “File” on the [SETUP] page.

- **[REC]/[REC STOP] function button**

Starts/stop recording.

The filename of the file that you recorded is displayed during REC STOP.

- **[PLAY] /[PLAY STOP] function button**

Plays back/pauses the training file.

- **[AB REP] function button..... A→, A→B**

Repeatedly plays back audio between points A and B. You can use this to practice certain phrases in a song by playing them back over and over.

Press this button the first time to mark point A (A→ will display ; B will blink).

Press the button a second time to mark point B. The instrument will enter repeat playback mode (A→B will display).

Press this when repeat playback is enabled (a third time) to cancel repeat mode (nothing will display).

8. Press the [REC] function button to begin recording what you play.

The e/MERGE module will record the Aux In sound and the sound of your drum performance.



Press the [REC STOP] function button to stop recording.

Tip: You can record up to a maximum of one hour. Recording will automatically stop after one hour.

9. Press the [PLAY] function button to check what you have recorded.

Checking a recorded file

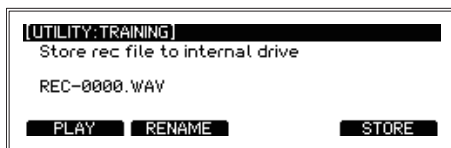

Press the EXIT button to cancel recording. The file will not be saved. The recorded data will be discarded, and the display will return to the TRAINING page.

- **[PLAY]/[STOP] function button**
Plays back/stops playback of a recorded file.
- **[RENAME] function button**
Renames a file that you have recorded. (→ p.16 “Renaming”)
- **[STORE] function button**
Stores a recorded file in internal memory.

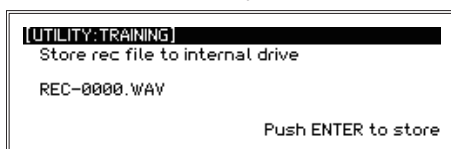

Press the ENTER button to store your recorded file. After the file has been stored, the display will return to the TRAINING page. Press the EXIT button if you wish to cancel the save operation. The file will not be saved, and the display will return to the record confirmation page.

Tip: You can also export to a USB flash drive using “Save Internal Rec File” in DATA MANAGEMENT, to use the WAV file with the song function.

TRIGGER PAD

This configures the settings for each trigger pad.



- **Trigger In** **Snare, Tom1, Tom1Rim, Tom2, Tom2Rim, Tom3, Tom3Rim, Kick, Hi-Hat, Crash, Ride, Tom4/Acc1, Acc2, Acc3**

Select each trigger pad to configure.

- **Trigger Type**

Select the type for the selected trigger pad.

The selection type differs for each Trigger In setting.

Trigger In	Type
Snare	EM-14S, OTHER, NO-PAD
Tom1/2/3	EM-10T/12T/14T, OTHER, NO-PAD
Tom1/2/3Rim	--- (TriggerType cannot be selected.)
Kick	EM-KCPC/EBP, OTHER, NO-PAD
Hi-Hat	EM-14HH, OTHER, NO-PAD
Crash	EM-15C, EM-18R, OTHER, NO-PAD
Ride	EM-18R, OTHER, NO-PAD
TOM4/ACC1, ACC2, ACC3	EM-14S, EM-10T/12T/14T, EM-15C, EM-18R, EM-KCPC/EBP, OTHER, NO-PAD

Tip: "EM-???" indicates names of pads used specifically for this instrument.

Note: Select "OTHER" if you are using pads aside from dedicated e/MERGE pads.

Each trigger setting must be set and adjusted for the pads to be used, when "OTHER" is selected. Some pads may not be usable with this instrument.

- **Sensitivity**..... **000...100**

Adjusts the trigger sensitivity.

- **Threshold**..... **000...100**

Adjusts how much the pad will react when struck.

Note: If you lower this value, the pad will sound even when you play lightly. Note that other pads may react as well when the specified pad is played. If you raise this value, the pad may not sound at all when you play lightly.

- **Retrigger** **000...100**

This makes adjustments to improve retriggering.

Note: Increase the retriggering value to avoid pads sounding two notes when played only once. Note that this will make the pad less able to detect drum rolls. When you lower this value, you will be able to play intricate flams, but the pad will be more likely to sound twice with one stroke.

• **Crosstalk Cancel** **Off, On**

You can configure the e/MERGE to cancel out the resonance from other pads when a pad sounds. Turn this on to reduce resonance.

Note: When this is set to “On,” striking two pads at the same time may be considered as resonance, and the sound from one of the pads may not be heard as a result. If this happens, turn the setting off and check again.

[STORE] function button

Press the [STORE] function button to store the settings. Press the EXIT button to cancel the settings.

HI-HAT CALIBRATION

Used to adjust the open/close action of the hi-hat cymbal.

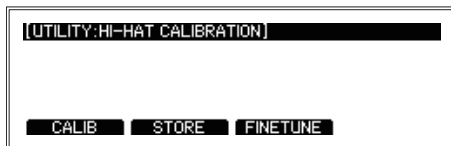

[CALIB] function button

If the action doesn't feel right or when you are making the settings for the first time, you will need to perform calibration.

- **Adjusting the Hi-Hat Open position**

Stabilize the sensor on the top pad of the hi-hat cymbal so that it does not touch the bottom pad (with the hi-hat open), and calibrate the hi-hat cymbal when open.

When the message below appears, press the ENTER button.

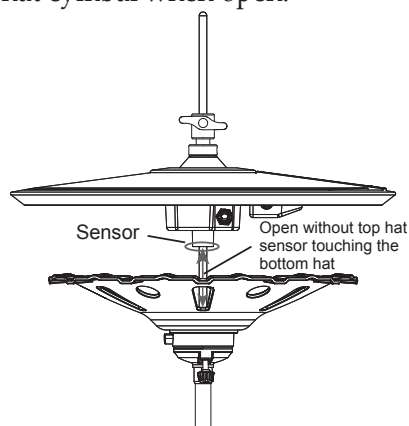
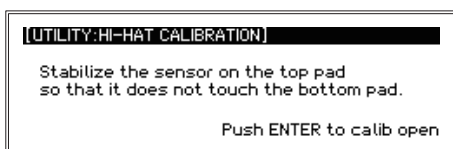

- **Adjusting the Hi-Hat Close position**

Free the clutch of the hi-hat cymbal's top pad, leaving the top pad of the hi-hat resting on the bottom pad. Calibrate the hi-hat in closed position.

When the message below appears, press the ENTER button.

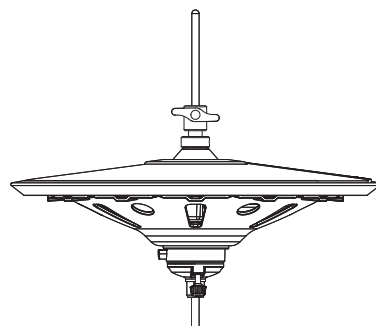
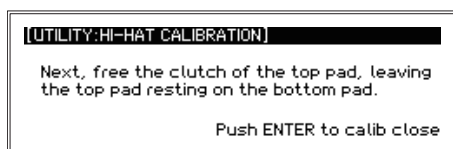

"Completed!" will be displayed, which confirms the calibration settings.

 If the calibration settings are incorrect, "Calibration Error" will be displayed. Try adjusting once more.

[FINE TUNE] function button

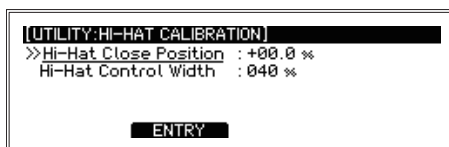

- Hi-Hat Close Position -50...+50%**
 This parameter is used to fine-tune the adjustment of the hi-hat close position after calibration. Increment this value to move the closing position up, and decrement this value to move the closing position down. Press the [ENTRY] function button to confirm the fine-tuning value.
- Hi-Hat Control Width 0%...100%**
 With the hi-hat sensor operating range (which you set during calibration) at 100%, set the range within which the sound changes from closed to open. Setting a smaller value will make the distance between closed and open more narrow, which will make the hi-hat action speedier. However, this will also make it harder to finely control the hi-hat. Press the [ENTRY] function button to confirm the value you set.

[STORE] function button

Press the [STORE] function button to store the settings. Press the EXIT button to cancel the settings.

PAD FUNCTION

Some of the button actions on this module, such as drum kit selection or tap tempo, can also be activated by hitting the pads instead.

Note: Pads to which a function has been assigned cannot be used to make a sound.



Pads to which pad functions can be assigned: No Assign, Snare, Tom1, Tom1Rim, Tom2, Tom2Rim, Tom3, Tom3Rim, Kick, Hi-Hat, Crash, Ride, Tom4/Acc1, Tom4/Acc1Rim*, Acc2, Acc2Rim*, Acc3, Acc3Rim*

Note: (*) When assigning a Crash instrument type to ACC1/2/3, Acc1Rim, Acc2Rim and Acc3Rim will not operate as pad functions. (→ p.68 "Inst List")

- **Song Start/Pause**
Plays back/pauses the currently selected song.
- **Song Start/Stop**
Plays back/stops the currently selected song.
- **Phrase Trigger**
Start playback of the currently selected song from the top when a set pad is struck.
- **Metronome Start/Stop**
Starts and stops the metronome
- **Tap Tempo**
This allows you to tap to set the metronome tempo.
- **KIT+**
Moves to the next drum kit after the currently selected drum kit.
- **KIT-**
Moves to the previous drum kit before the currently selected drum kit.

[STORE] function button

Press the [STORE] function button to store the settings. Press the EXIT button to cancel the settings.

DIRECT OUT

This assigns the pads to the DIRECT OUT 1–8 jacks. You can also set the output for the song project.



Note: The sound of the pads set in DIRECT OUT and the metronome sound will not be routed to the MASTER OUT jacks.

- **Direct Out1...8**
**Mute, Snare, Tom1, Tim1Rim, Tom2, Tom2Rim, Tom3, Tom3Rim, Kick, Hi-Hat, Crash, Ride, Tom4/
 Acc1, Acc2, Acc3, Song MusicLR, Song MusicL, Song MusicR, Song Click, Metronome**
 Mixed sound from DIRECT OUT and MASTER OUT is routed to the Ω (Headphones) jack.

The sound output from the DIRECT OUT jacks cannot be adjusted.
 Please refer to Mixer block diagram (→ p. 77) for more details.

[STORE] function button

Press the [STORE] function button to store the settings. Press the EXIT button to cancel the settings.

METRONOME

Selects whether the metronome sound is routed to the MASTER OUT jacks.

- **Master Out** **Off, On**
 To output the metronome sound from the MASTER OUT jacks, set this to “On.”
Note: When DIRECT OUT is set to “Metronome,” the sound will not be routed to the MASTER OUT jacks, even if this is set to “On.”

[STORE] function button

Press the [STORE] function button to store the settings. Press the EXIT button to cancel the settings.

INPUT GAIN

This sets the input gain for the AUX In jack and USB audio.



- **Aux In** -20.0 ... +00.0 ... +10.0 db (+/-0.5 db)
This adjusts the input gain for the AUX IN jack.
- **USB Audio In**..... -20.0 ... +00.0 ... +10.0 db (+/-0.5 db)
Adjusts the input gain for the USB audio.

[STORE] function button

Press the [STORE] function button to store the settings. Press the EXIT button to cancel the settings.

MIDI

Configures the settings for transmitting and receiving MIDI signals.

You can set the tempo clock source, MIDI channel, enable/disable each message and set the note number (0–127) to output for each pad.



- **Clock In** **Internal, External**
Tip: External clocks can only be received via USB-MIDI.
- **MIDI Channel**..... **01...16**
Specifies the MIDI channel of the module.
If you want to transmit or receive program changes set the MIDI channel to match the MIDI channel of the connected MIDI device.
- **Transmit Program Change** **Off, On**
Specifies which Program changes are not transmitted.
- **Receive Program Change** **Off, On**
Specifies which Program changes are not received.
Tip: Program changes can only be received via USB-MIDI.
- **Hi-Hat Pedal CC** **000...119**
Sets the CC (control change) number to be sent when operating the hi-hat pedal.
- **Transmit Hi-Hat Pedal CC** **Off, On**
Turns CC data output off/on for when the hi-hat pedal is operated.
- **Hi-Hat Pedal Close Point** **000...127**
Sets the switch position between the hi-hat close note and hi-hat open note for the hi-hat pedal.

The parameters below specify the note numbers to be sent when each pad is struck.

- **Snare Head Note** 000...127
- **Snare Rim Note** 000...127
- **Snare Close Stick Note** 000...127
- **Tom1 Head Note** 000...127
- **Tom1 Rim Note** 000...127
- **Tom2 Head Note** 000...127
- **Tom2 Rim Note** 000...127
- **Tom3 Head Note** 000...127
- **Tom3 Rim Note** 000...127
- **Kick Note**..... 000...127
- **Hi-Hat Open Bow Note**..... 000...127
- **Hi-Hat Open Edge Note**..... 000...127
- **Hi-Hat Close Bow Note**..... 000...127
- **Hi-Hat Close Edge Note**..... 000...127
- **Hi-Hat Pedal Close Note**..... 000...127
- **Crash Bow Note** 000...127
- **Crash Edge Note**..... 000...127
- **Crash Choke Note** 000...127
- **Ride Bow Note** 000...127
- **Ride Edge Note** 000...127
- **Ride Choke Note** 000...127
- **Ride Cup Note**..... 000...127
- **Tom4/Acc1 Head/Bow Note** 000...127
- **Tom4/Acc1 Rim/Edge Note** 000...127
- **Tom4/Acc1 Choke Note** 000...127
- **Acc2 Head/Bow Note** 000...127
- **Acc2 Rim/Edge Note** 000...127
- **Acc2 Choke Note**..... 000...127
- **Acc3 Head/Bow Note** 000...127
- **Acc3 Rim/Edge Note** 000...127
- **Acc3 Choke Note**..... 000...127

[STORE] function button

Press the [STORE] function button to store the settings. Press the EXIT button to cancel the settings.

DATA MANAGEMENT

These are functions for saving, loading, deleting and otherwise handling the different types of data for this module (such as user kits, system data and so on). When using an external device, connect a USB flash drive.



Basic data management operations

1. Select DATA MANAGEMENT from the UTILITY menu, and press the ENTER button to enter the DATA MANAGEMENT menu screen.



2. Use the dial to select the DATA MANAGEMENT function group, and press the ENTER button.



3. Select the DATA MANAGEMENT function in the group using the dial, and press the ENTER button to display the screen for the selected function.

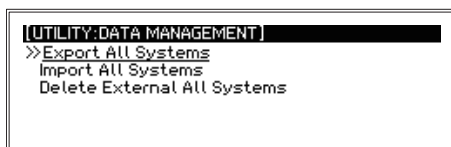

4. The screen returns to its previous state after executing each DATA MANAGEMENT operation.
5. To return to the DATA MANAGEMENT menu, press the EXIT button.

To execute other data management functions, repeat the process shown above.

Tip: “Internal memory” refers to the memory in this instrument, whereas “external memory” refers to a USB flash drive.

User Kit

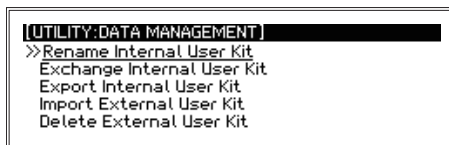

Rename Internal User Kit

Renames user drum kit data stored in internal memory.

- **Rename User Kit** **Rename (up to 24 characters)**

Use the dial to select a drum kit to rename.

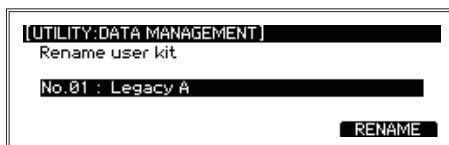

Press the [RENAME] function button to rename the drum kit (→ p.16 “Renaming”).

Exchange Internal User Kit

Exchanges the user drum kits stored in internal memory.

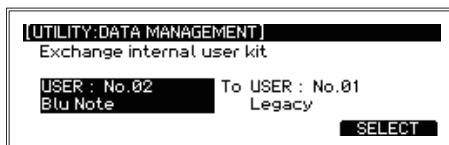

Select the drum kit to replace with (the source drum kit) using the dial, and press the [SELECT] function button. Select the drum kit to be replaced (the destination drum kit) using the dial.

Press the ENTER button to execute. Press the EXIT button to cancel.

Tip: If you have selected the same number, the text “Same Number” appears on the display. Cancel out the error message by pressing the EXIT button, and select a different number.

Export Internal User Kit

This saves the user drum kit data stored in internal memory to USB flash drive. Either a single drum kit or all drum kits can be stored.

Note: If there are no data files stored on the USB flash drive, a file will be created.



- **Internal**..... **USER: No.xx, ALL KIT**

Select the source drum kit in internal memory using the dial, and press the [SELECT] function button.

• **External** **USER : No.xx, ALL KIT**

Select the destination drum kit on the USB flash drive using the dial.
Press the ENTER button to execute. Press the EXIT button to cancel.

Import External User Kit

This loads the user drum kit data stored in USB flash drive to internal memory. Either a single drum kit or all drum kits can be loaded.



• **External** **USER : No.xx, ALL KIT**

Select the source drum kit to load on the USB flash drive using the dial, and press the [SELECT] function button.

• **Internal**..... **USER : No.xx, ALLKIT**

Select the destination drum kit in internal memory using the dial.
Press the ENTER button to execute. Press the EXIT button to cancel.

Delete External User Kit

Deletes a single drum kit from the user drum kit data stored on a USB flash drive, and initializes the data.

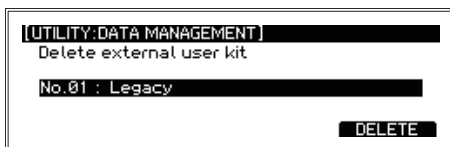

Select the drum kit to delete from the USB flash drive using the dial.
Press the [DELETE] function button to go to the Delete execute screen.

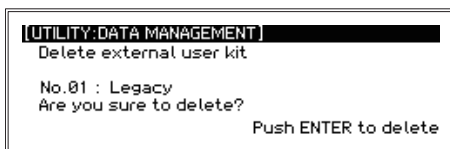

Press the ENTER button to execute. Press the EXIT button to cancel.

All Systems

“All Systems” means all of the data stored, including each setting, the user drum kits and metronome projects.

Note: This does not include WAV files recorded to internal memory using the training function (Internal Rec Files).

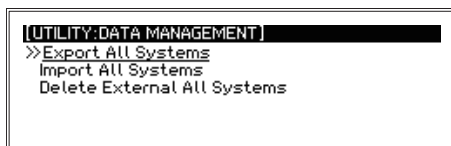

Export All Systems

Stores the All Systems data that is currently set to a USB flash drive.

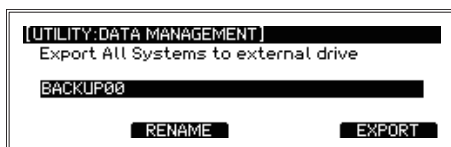

Press the [EXPORT] function button to go to the Export execute screen.

Press the [RENAME] function button to rename the All Systems data that is stored (→ p.16 “Renaming”).

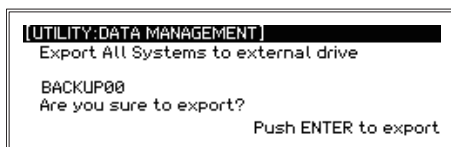

Press the ENTER button to execute. Press the EXIT button to cancel.

Import All Systems

Loads the All Systems data into internal memory from a USB flash drive.

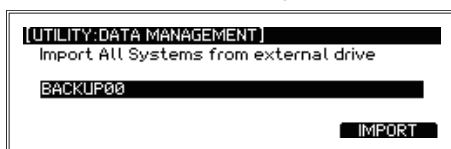

Use the dial to select the All Systems data to be loaded.

Press the [IMPORT] function button to go to the Import execute screen.

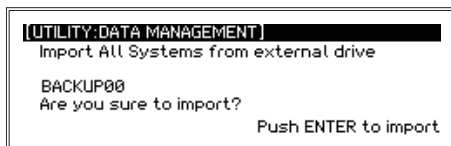

Press the ENTER button to execute. Press the EXIT button to cancel.

Delete External All Systems

Deletes selected the All Systems data that is stored on a USB flash drive.

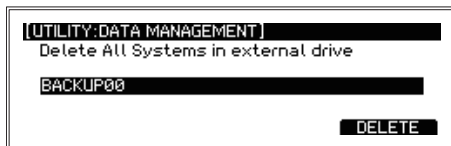

Use the dial to select the All Systems data to delete.
Press the [DELETE] function button to go to the execute screen.

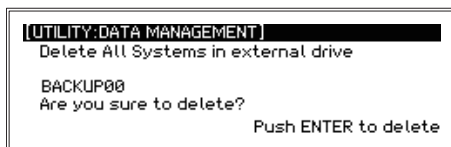

Press the ENTER button to execute. Press the EXIT button to cancel.

Internal Rec File

“Internal Rec File” is a WAV file recorded to internal memory using the training function.

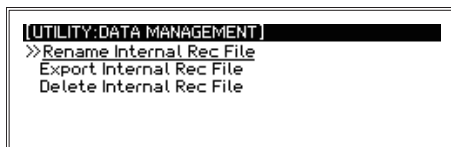

Rename Internal Rec File

This changes the name of Internal Rec Files.

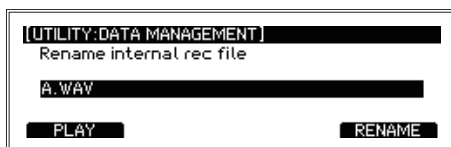

Select an internal rec file using the dial.
Press the [PLAY] function button to play back the file.
Press the [RENAME] function button to go to the Rename screen (→ p.16 “Renaming”).

Export Internal Rec File

Stores an internal rec file to a USB flash drive.

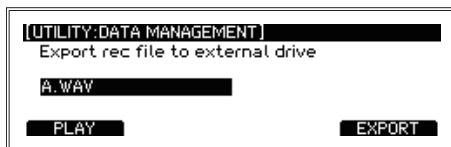

Select an internal rec file using the dial.
Press the [PLAY] function button to play back the file.
Press the [EXPORT] function button to go to the Export execute screen.

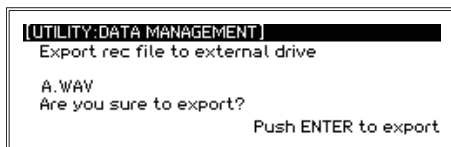

Press the ENTER button to execute. Press the EXIT button to cancel.

Delete Internal Rec File

Deletes an internal rec file.

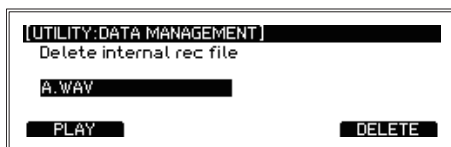

Select an internal rec file using the dial.

Press the [PLAY] function button to play back the file.

Press the [DELETE] function button to go to the Delete execute screen.

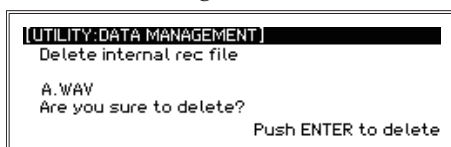

Press the ENTER button to execute. Press the EXIT button to cancel.

All Metronome Projects

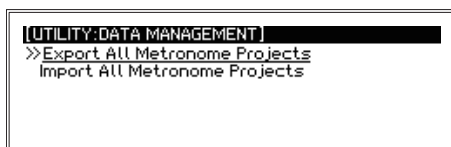

Export All Metronome Projects

Stores all metronome project data to a USB flash drive.

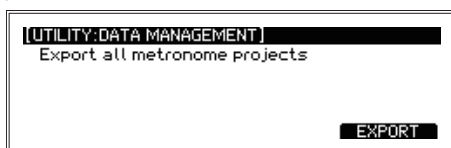

Press the [EXPORT] function button to go to the Export execute screen.

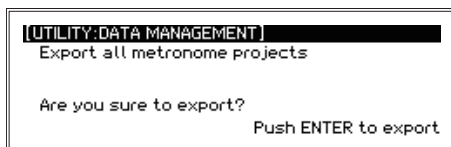

Press the ENTER button to execute. Press the EXIT button to cancel.

Import All Metronome Projects

Loads all metronome projects from a USB flash drive.



Press the [IMPORT] function button to go to the Import execute screen.

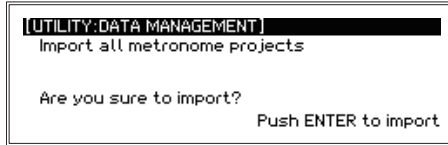

Press the ENTER button to execute. Press the EXIT button to cancel.

AUTO POWER OFF

Sets whether the auto power off function is enabled or disabled.

When this function is enabled, the power will automatically shut off if there is no input from the pads or no signal is received from any of the input jacks for a certain period of time.

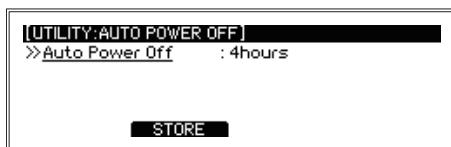

- **Auto Power Off** **Disable, 4hours**

Shows the current auto power off settings. (The default setting is 4 hours.)

Use the dial if you wish to change this to a different setting.

Tip: The auto power off count will be canceled under any of the following conditions:
 Audio input is received, panel is operated, a pad is triggered, a song is played back, a training recording is played back, the metronome is in use

[STORE] function button

Press the [STORE] function button to store the settings. Press the EXIT button to cancel the settings.

DISPLAY

This adjusts the contrast and brightness of the display.

This function also turns the light of the kick pad on and off.

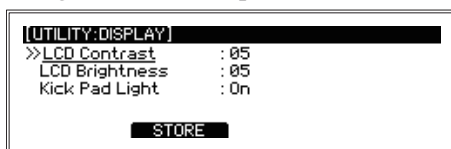

- **LCD Contrast** **01...10**

Adjusts the display contrast.

- **LCD Brightness** **01...10**

Adjusts the brightness of the display backlight.

- **Kick Pad Light** **Off, On**

Switches the kick pad light on/off.

Note: The light can only be turned on/off if the trigger type for the kick pad is set to "EM-KCPC/EBP" (→ p.40 "TRIGGER PAD").

[STORE] function button

Press the [STORE] function button to store the settings. Press the EXIT button to cancel the settings.

FACTORY RESET

You can restore all of the e/MERGE modules settings to their factory-set default state.

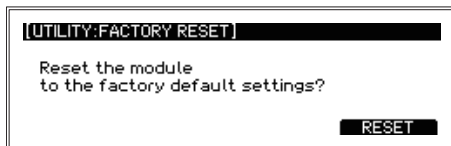

1. Press the [RESET] function button.

A message will display on the page to confirm the reset procedure.

Press the EXIT button to cancel and return to the previous page.]

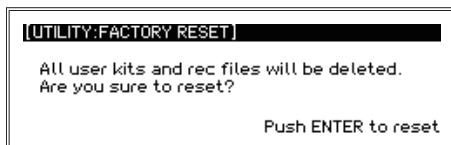

2. Press the ENTER button.

The module will be restored to its factory default settings.

-  Any user drum kits, system data and other settings that you have made, as well as data recorded using the training function will be deleted, and cannot be recovered. Before continuing with this operation, make sure that you want to delete the data and settings. Back up any user data, training recording data and other data you want to keep to a USB flash drive (→ p.51 “Export All Systems”), (→ p.52 “Export Internal Rec File”).

PROTECT

Prohibits the information in internal memory from being written to (overwritten).

Tip: Any recording you make during training can be saved even when the protect function is on.

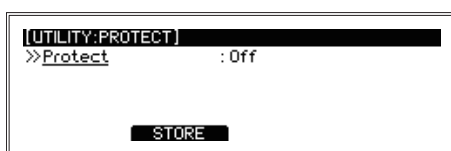

- **Protect**..... [Off, On]

Use the dial to turn “Protect” on/off.

[STORE] function button

Press the [STORE] function button to store the settings. Press the EXIT button to cancel the settings.

USB MEMORY FORMAT

This formats (initializes) the USB flash drive.

Before using a USB flash drive with the e/MERGE module, you must format (initialize) the flash drive.

- ⚠ Formatting the USB flash drive will erase all data that has been saved. Back up any data on the flash drive that you wish to save by copying it to your computer or other device, before formatting the drive.

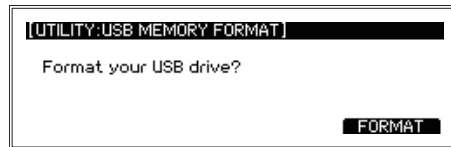

1. Press the [FORMAT] function button.

A message will display on the page to confirm the format procedure.

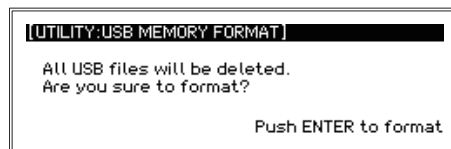

2. Press the ENTER button.

The formatting operation will begin.

To cancel formatting, press the EXIT button.

SYSTEM INFO

Checks the system version of the e/MERGE module. This is also used for updating the system.

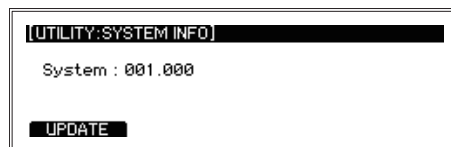

You can confirm the current system version used by the e/MERGE.

Insert a USB flash drive containing the system file, and press the [UPDATE] button to update the system. Refer to the version update documentation for how to update the system.

Appendix

Troubleshooting

If you encounter any problems while using the e/MERGE, check the points shown below. If the instrument still does not operate correctly, please contact your local Pearl distributor.

The e/MERGE won't turn on.

- Make sure that the AC adapter is correctly plugged into this instrument and into the AC outlet.
- Make sure that the AC adapter power cord is fully plugged into the AC adapter. (→ p.10 "Connecting the included AC adapter")

No sound is heard when the pads are played.

- Check the connections between the e/MERGE and the pads. (→ p.8 "Settings")
- Turn the MASTER OUT knob and the HEADPHONES OUT knob clockwise.
- Check whether any functions have been set using the PAD FUNCTION in UTILITY. (→ p.44 "PAD FUNCTION")

No sound can be heard when trying to use the song function or training function to play back the files on a USB flash drive.

- Turn the INPUT knob clockwise.
- Turn the MASTER OUT knob and the HEADPHONES OUT knob clockwise.

The metronome sound cannot be heard, even when turned on.

- Turn the INPUT knob clockwise.
- If the Master Out setting for the METRONOME is off, the metronome will not be routed to the MASTER OUT L/MONO and R jacks.
- If the metronome output destination is set to the DIRECT OUT jack in the DIRECT OUT settings, the metronome will not be routed to the MASTER OUT L/MONO and R jacks.

Songs on the USB flash drive will not load.

- Be sure to format the USB flash drive on the e/MERGE before using it. (→ p.57 "USB MEMORY FORMAT")
- The specs for files that can be loaded into the e/MERGE are as follows:
 - WAV files (PCM format)
 - Sampling frequency: 44.1 kHz
 - Bit length: 16 bits
 - Maximum 4 hours (stereo/mono)
- Each file added to the USB flash drive needs to be placed in the root directory (the top-most directory of the USB flash drive).

Either the music track or the click track cannot be heard in Song mode.

- Check the settings for each track. (→ p.30 “Registering a WAV file in a song project”)
- The click track sound will not be routed to the MASTER OUT L/MONO, R jacks.
- When setting the song output destination in DIRECT OUT settings to the DIRECT OUT jacks, sound will not be routed to the MASTER OUT L/MONO, R jacks.
- Adjust the BALANCE knob.
(→ p.6 “13. BALANCE knob, SONG START/STOP button”)

The hi-hat does not sound right.

- Calibrate the hi-hat. (→ p.42 “HI-HAT CALIBRATION”)

When I hit two pads at the same time, I only hear sound from one pad.

- The e/MERGE is configured by factory-set default to cancel out the resonance from other pads when a pad sounds.
Set Crosstalk Cancel to “Off” in TRIGGER PAD in the UTILITY menu. (→ p.40 “TRIGGER PAD”)

Error messages

Error messages	Cause of error and how to solve
Store Error	<p>An error has occurred when writing to or reading from a file in internal memory or on a USB flash drive.</p> <p>If errors occur frequently, use a different USB flash drive. Contact our service representative if you encounter errors after several unsuccessful tries of writing to or reading from internal memory.</p>
Import Error	
Export Error	
Load Error	
Copy Error	
Move Error	
Delete Error	
Setup Error	
Data Load Error	<p>An error has occurred when loading the parameter data used by the system.</p> <p>Turn the power off and on again. If the error is still present after cycling the power, contact our service representative.</p>
PCM Load Error	<p>An error occurred when loading the PCM data used in a drum kit.</p> <p>If errors occur frequently, contact our service representative.</p>
Song Setup Error	<p>An error occurred when making song playback settings.</p> <p>Check the contents of the project and the WAV file registered.</p>
Memory Full	<p>There is no more recording time available.</p> <p>Export the WAV files stored in internal memory to USB flash drive, and then delete them.</p>
Same name file exists	<p>There is already a file with the same name.</p> <p>Use a different filename, and store the file again.</p>
Can not record	<p>The instrument is not yet ready to record.</p>
Now recording	<p>You cannot exit the TRAINING page because the unit is still recording.</p> <p>Stop recording.</p>
Already assigned	<p>Since the file has already been registered as a playback file, you cannot delete it.</p> <p>Deregister the file as a playback file first, and then delete the file.</p>
Invalid Name	<p>Renaming is disabled.</p> <p>If you have not inputted any characters, input some characters and then perform the ENTRY function.</p>
Same Number	<p>The operation cannot be performed because the numbers are the same (during "Exchange Internal Kit").</p> <p>Select a different number to do this.</p>
No Data File Exists	<p>There are no user drum kits or metronome project files stored on the USB flash drive.</p> <p>Export the files before importing.</p>
Calibration Error	<p>An error occurred during calibration.</p> <p>Try calibrating again.</p>
Format Error	<p>An error occurred when formatting the USB flash drive.</p> <p>If an error still occurs after trying this several times, use a different USB flash drive.</p>
External Drive Full	<p>The data file could not be created or stored, due to insufficient memory remaining on the USB flash drive.</p> <p>Delete any files on the USB flash drive that you do not need.</p>
Memory Protected	<p>The memory protect feature is on.</p> <p>Turn the memory protect feature off.</p>
Can not make data folder	<p>A folder could not be created on the USB flash drive to store the data file.</p> <p>Make sure that there are no other files or folders with the same name on your USB flash drive.</p>

Preset Drum Kit List

Category	#	DrumKitName	AMBIENCE	Pad Assign	#	Inst Name
NATURAL	1	Legacy	○	Snare	S25	SD15x5-SensiTone Mahogny
				Tom1	T01	Tom12x8-Masters Maple
				Tom1Rim	80	*Tom12x8-Masters Mpl RS
				Tom2	T02	Tom13x9-Masters Maple
				Tom2Rim	82	*Tom13x9-Masters Mpl RS
				Tom3	T05	Tom16x16-Masters Maple
				Tom3Rim	86	*Tom16x16-Masters Mpl RS
				Kick	K01	BD22x16-Masters Maple
				Hi-Hat	H02	HH14-Pst-2002
				Crash	C01	Crash16-Sbn-AAX
				Ride	R02	Ride20-Sbn-AAX
				Tom4/Acc1	T06	Tom18x16-Masters Maple
				Acc2	C02	Crash18-Sbn-AAX
				Acc3	---	
				2	Blu Note	○
	Tom1	T23	Tom10x7-RF Blu Note			
	Tom1Rim	117	*Tom10x7-RF Blu Note RS			
	Tom2	T24	Tom12x8-RF Blu Note			
	Tom2Rim	119	*Tom12x8-RF Blu Note RS			
	Tom3	T25	Tom14x14-RF Blu Note			
	Tom3Rim	121	*Tom14x14-RF Blu Note RS			
	Kick	K08	BD18x14-RF Blu Note			
	Hi-Hat	H03	HH15-Zld-K			
	Crash	C04	Crash18-Zld-K			
	Ride	R04	Ride22-Zld-KERO			
	Tom4/Acc1	T26	Tom14x14-RF Blu Note L			
	Acc2	C07	CR-Ride19-Sbn-HHX			
	Acc3	---				
	3	Crystal Clear	○			
				Tom1	T28	Tom12x8-Crystal Beat
				Tom1Rim	125	*Tom12x8-Crystal Beat RS
				Tom2	T29	Tom14x14-Crystal Beat
				Tom2Rim	127	*Tom14x14-CrystalBeat RS
				Tom3	T31	Tom18x16-Crystal Beat
				Tom3Rim	131	*Tom18x16-CrystalBeat RS
				Kick	K11	BD24x16-Crystal Beat
				Hi-Hat	H02	HH14-Pst-2002
				Crash	C05	Crash19-Pst-2002
				Ride	R03	Ride22-Pst-2002
				Tom4/Acc1	T32	Tom18x16-Crystal Beat L
				Acc2	C06	Crash22-Pst-2002
				Acc3	---	
				4	Studio Reference	○
	Tom1	T14	Tom8x7-Reference Pure			
	Tom1Rim	98	*Tom8x7-Ref Pure RS			
	Tom2	T15	Tom10x7-Reference Pure			
	Tom2Rim	100	*Tom10x7-Ref Pure RS			
	Tom3	T17	Tom14x14-Reference Pure			
	Tom3Rim	104	*Tom14x14-Ref Pure RS			
	Kick	K07	BD22x18-Reference Pure			
Hi-Hat	H02	HH14-Pst-2002				
Crash	C01	Crash16-Sbn-AAX				
Ride	R02	Ride20-Sbn-AAX				
Tom4/Acc1	T18	Tom16x16-Reference Pure				
Acc2	C02	Crash18-Sbn-AAX				
Acc3	---					
5	In Session	○	Snare			
			Tom1	T34	Tom12x8-Session	
			Tom1Rim	135	*Tom12x8-Session RS	
			Tom2	T35	Tom14x14-Session	
			Tom2Rim	137	*Tom14x14-Session RS	
			Tom3	T36	Tom16x16-Session	
			Tom3Rim	139	*Tom16x16-Session RS	
			Kick	K12	BD22x16-Session	
			Hi-Hat	H04	HH16-Sbn-AAX	
			Crash	C01	Crash16-Sbn-AAX	
			Ride	R02	Ride20-Sbn-AAX	
			Tom4/Acc1	T37	Tom16x16-Session L	
			Acc2	C02	Crash18-Sbn-AAX	
			Acc3	---		

Category	#	DrumKitName	AMBIENCE	Pad Assign	#	Inst Name
MODERN	1	Recipe	○	Snare	S12	SD14x5-SensiTone Steel
				Tom1	T08	Tom12x9-Reference
				Tom1Rim	90	*Tom12x9-Reference RS
				Tom2	T09	Tom13x10-Reference
				Tom2Rim	92	*Tom13x10-Reference RS
				Tom3	T10	Tom16x16-Reference
				Tom3Rim	94	*Tom16x16-Reference RS
				Kick	K07	BD22x18-Reference Pure
				Hi-Hat	H02	HH14-Pst-2002
				Crash	C05	Crash19-Pst-2002
				Ride	R03	Ride22-Pst-2002
				Tom4/Acc1	T12	Tom18x16-Reference
				Acc2	C06	Crash22-Pst-2002
				Acc3	---	
	2	Reznor	○	Snare	S24	SD14x8-FreeFloat Mahogny
				Tom1	T55	Tom12x8-Session Resnor
				Tom1Rim	135	*Tom12x8-Session RS
				Tom2	T56	Tom14x14-Session Resnor
				Tom2Rim	137	*Tom14x14-Session RS
				Tom3	T57	Tom16x16-Session Resnor
				Tom3Rim	139	*Tom16x16-Session RS
				Kick	K04	BD20x14-Wood Fiber
				Hi-Hat	H01	HH13-Sbn-HHX
				Crash	C01	Crash16-Sbn-AAX
				Ride	R02	Ride20-Sbn-AAX
				Tom4/Acc1	T58	Tom16x16-Session Rsnr L
				Acc2	C02	Crash18-Sbn-AAX
				Acc3	---	
	3	Surfacing	○	Snare	S14	SD14x55-Modern Maple
				Tom1	T50	Tom12x8-Masters Surface
				Tom1Rim	143	*Tom12x8-MasterF-Call RS
				Tom2	T51	Tom13x9-Masters Surface
				Tom2Rim	145	*Tom13x9-MasterF-Call RS
				Tom3	T52	Tom14x14-Masters Surface
				Tom3Rim	147	*Tom14x14-MsterF-Call RS
				Kick	K15	BD22x16-Masters Surface
				Hi-Hat	H02	HH14-Pst-2002
				Crash	C01	Crash16-Sbn-AAX
				Ride	R02	Ride20-Sbn-AAX
				Tom4/Acc1	T53	Tom16x16-Masters Surface
				Acc2	C02	Crash18-Sbn-AAX
				Acc3	---	
	4	Ref-Tones	○	Snare	S13	SD14x55-Masters Maple
				Tom1	T14	Tom8x7-Reference Pure
				Tom1Rim	98	*Tom8x7-Ref Pure RS
				Tom2	T15	Tom10x7-Reference Pure
				Tom2Rim	98	*Tom8x7-Ref Pure RS
				Tom3	T17	Tom14x14-Reference Pure
				Tom3Rim	104	*Tom14x14-Ref Pure RS
				Kick	K07	BD22x18-Reference Pure
				Hi-Hat	H02	HH14-Pst-2002
				Crash	C01	Crash16-Sbn-AAX
				Ride	R02	Ride20-Sbn-AAX
				Tom4/Acc1	T18	Tom16x16-Reference Pure
				Acc2	C11	Splash10-Sbn-AAX
				Acc3	---	
	5	Sandman	○	Snare	S20	SD14x65-SensiTone Brass
				Tom1	T45	Tom13x10-RF Sandman
				Tom1Rim	92	*Tom13x10-Reference RS
				Tom2	T46	Tom16x16-RF Sandman
				Tom2Rim	94	*Tom16x16-Reference RS
				Tom3	T47	Tom18x16-RF Sandman
				Tom3Rim	96	*Tom18x16-Reference RS
				Kick	K14	BD22x18-RF Sandman
				Hi-Hat	H04	HH16-Sbn-AAX
				Crash	C01	Crash16-Sbn-AAX
				Ride	R03	Ride22-Pst-2002
				Tom4/Acc1	T48	Tom18x16-RF Sandman L
				Acc2	C14	China20-Pst-2002
				Acc3	---	

Category	#	DrumKitName	AMBIENCE	Pad Assign	#	Inst Name
STUDIO	1	First Call	○	Snare	S08	SD14x35-FreeFloat1 Brass
				Tom1	T39	Tom12x8-Masters F-Call
				Tom1Rim	305	Cowbell CMP Edge
				Tom2	T40	Tom13x9-Masters F-Call
				Tom2Rim	145	*Tom13x9-MasterF-Call RS
				Tom3	T41	Tom14x14-Masters F-Call
				Tom3Rim	147	*Tom14x14-MsterF-Call RS
				Kick	K13	BD22x16-Masters F-Call
				Hi-Hat	H02	HH14-Pst-2002
				Crash	C05	Crash19-Pst-2002
				Ride	R03	Ride22-Pst-2002
				Tom4/Acc1	T42	Tom16x16-Masters F-Call
				Acc2	C06	Crash22-Pst-2002
				Acc3	---	
	2	Power Ballad	○	Snare	S24	SD14x8-FreeFloat Mahogny
				Tom1	T08	Tom12x9-Reference
				Tom1Rim	90	*Tom12x9-Reference RS
				Tom2	T09	Tom13x10-Reference
				Tom2Rim	92	*Tom13x10-Reference RS
				Tom3	T10	Tom16x16-Reference
				Tom3Rim	94	*Tom16x16-Reference RS
				Kick	K04	BD20x14-Wood Fiber
				Hi-Hat	H02	HH14-Pst-2002
				Crash	C05	Crash19-Pst-2002
				Ride	R03	Ride22-Pst-2002
				Tom4/Acc1	T11	Tom16x16-Reference L
				Acc2	C06	Crash22-Pst-2002
				Acc3	---	
	3	High Fidelity	○	Snare	S13	SD14x55-Masters Maple
				Tom1	T19	Tom12x8-Wood Fiber
				Tom1Rim	109	*Tom12x8-Wood Fiber RS
				Tom2	T20	Tom13x9-Wood Fiber
				Tom2Rim	111	*Tom13x9-Wood Fiber RS
				Tom3	T21	Tom14x14-Wood Fiber
				Tom3Rim	113	*Tom14x14-Wood Fiber RS
				Kick	K12	BD22x16-Session
				Hi-Hat	H03	HH15-Zld-K
				Crash	C01	Crash16-Sbn-AAX
				Ride	R03	Ride22-Pst-2002
				Tom4/Acc1	T22	Tom16x16-Wood Fiber
				Acc2	C02	Crash18-Sbn-AAX
				Acc3	---	
	4	Polyrhythmic Grv	○	Snare	S11	SD14x5-Reference Pure
Tom1				T14	Tom8x7-Reference Pure	
Tom1Rim				98	*Tom8x7-Ref Pure RS	
Tom2				T15	Tom10x7-Reference Pure	
Tom2Rim				100	*Tom10x7-Ref Pure RS	
Tom3				T17	Tom14x14-Reference Pure	
Tom3Rim				104	*Tom14x14-Ref Pure RS	
Kick				K07	BD22x18-Reference Pure	
Hi-Hat				H02	HH14-Pst-2002	
Crash				C01	Crash16-Sbn-AAX	
Ride				R03	Ride22-Pst-2002	
Tom4/Acc1				T18	Tom16x16-Reference Pure	
Acc2				C02	Crash18-Sbn-AAX	
Acc3				---		
5	Mod Soul	○	Snare	S09	SD14x35-FreeFloat2 Brass	
			Tom1	T27	Tom10x7-Crystal Beat	
			Tom1Rim	123	*Tom10x7-Crystal Beat RS	
			Tom2	T28	Tom12x8-Crystal Beat	
			Tom2Rim	125	*Tom12x8-Crystal Beat RS	
			Tom3	T31	Tom18x16-Crystal Beat	
			Tom3Rim	131	*Tom18x16-CrystalBeat RS	
			Kick	K04	BD20x14-Wood Fiber	
			Hi-Hat	H03	HH15-Zld-K	
			Crash	C01	Crash16-Sbn-AAX	
			Ride	R03	Ride22-Pst-2002	
			Tom4/Acc1	T31	Tom18x16-Crystal Beat	
			Acc2	C02	Crash18-Sbn-AAX	
			Acc3	---		

Category	#	DrumKitName	AMBIENCE	Pad Assign	#	Inst Name
VINTAGE	1	Recking Kru	○	Snare	S13	SD14x55-Masters Maple
				Tom1	T19	Tom12x8-Wood Fiber
				Tom1Rim	109	*Tom12x8-Wood Fiber RS
				Tom2	T20	Tom13x9-Wood Fiber
				Tom2Rim	111	*Tom13x9-Wood Fiber RS
				Tom3	T21	Tom14x14-Wood Fiber
				Tom3Rim	115	*Tom16x16-Wood Fiber RS
				Kick	K04	BD20x14-Wood Fiber
				Hi-Hat	H02	HH14-Pst-2002
				Crash	C01	Crash16-Sbn-AAX
				Ride	R02	Ride20-Sbn-AAX
				Tom4/Acc1	T22	Tom16x16-Wood Fiber
				Acc2	C02	Crash18-Sbn-AAX
				Acc3	---	
	2	NOLA Funk	○	Snare	S26	SD15x5-Vintage Mahogany
				Tom1	T63	Tom10x7-RF NOLA Funk
				Tom1Rim	177	*Tom10x7-RF NOLA Funk RS
				Tom2	T64	Tom12x8-RF NOLA Funk
				Tom2Rim	179	*Tom12x8-RF NOLA Funk RS
				Tom3	T65	Tom14x14-RF NOLA Funk
				Tom3Rim	181	*Tom14x14-RF NOLAFunk RS
				Kick	K17	BD22x16-SSC NOLA Funk
				Hi-Hat	H03	HH15-Zld-K
				Crash	C04	Crash18-Zld-K
				Ride	R04	Ride22-Zld-KERO
				Tom4/Acc1	T66	Tom14x14-RF NOLA Funk L
				Acc2	C03	Crash16-Zld-K
				Acc3	---	
	3	Funk n Soul	○	Snare	S05	SD12x7-Vintage Maple
				Tom1	T59	Tom10x7-RF Funk n Soul
				Tom1Rim	171	*Tom10x7-RF Funk Soul RS
				Tom2	T60	Tom12x8-RF Funk n Soul
				Tom2Rim	173	*Tom12x8-RF Funk Soul RS
				Tom3	T61	Tom14x14-RF Funk n Soul
				Tom3Rim	175	*Tom14x14-RF FunkSoul RS
				Kick	K09	BD18x14-RF Funk n Soul
				Hi-Hat	H01	HH13-Sbn-HHX
				Crash	C02	Crash18-Sbn-AAX
				Ride	R01	Ride19-Sbn-HHX
				Tom4/Acc1	T62	Tom14x14-RF FunkSoul L
				Acc2	C01	Crash16-Sbn-AAX
				Acc3	---	
4	Funkafize	○	Snare	S15	SD14x55-Vintage Maple	
			Tom1	T72	Tom12x8-FW Funkafize	
			Tom1Rim	193	*Tom12x8-FW Funkafiz RS	
			Tom2	T73	Tom13x9-FW Funkafize	
			Tom2Rim	195	*Tom13x9-FW Funkafiz RS	
			Tom3	T74	Tom14x14-FW Funkafize	
			Tom3Rim	199	*Tom16x16-FW Funkafiz RS	
			Kick	K02	BD20x16-Reference	
			Hi-Hat	H02	HH14-Pst-2002	
			Crash	C01	Crash16-Sbn-AAX	
			Ride	R02	Ride20-Sbn-AAX	
			Tom4/Acc1	T75	Tom16x16-FW Funkafize	
			Acc2	C02	Crash18-Sbn-AAX	
			Acc3	---		
5	Ramble	○	Snare	S19	SD14x65-Reference Brass	
			Tom1	T67	Tom10x7-CRB Ramble	
			Tom1Rim	123	*Tom10x7-Crystal Beat RS	
			Tom2	T68	Tom12x8-CRB Ramble	
			Tom2Rim	125	*Tom12x8-Crystal Beat RS	
			Tom3	T70	Tom16x16-CRB Ramble	
			Tom3Rim	305	Cowbell CMP Edge	
			Kick	K18	BD22x16-CRB Ramble	
			Hi-Hat	H02	HH14-Pst-2002	
			Crash	C05	Crash19-Pst-2002	
			Ride	R03	Ride22-Pst-2002	
			Tom4/Acc1	T70	Tom16x16-CRB Ramble	
			Acc2	C06	Crash22-Pst-2002	
			Acc3	---		

Category	#	DrumKitName	AMBIENCE	Pad Assign	#	Inst Name
ELECTRONIC	1	Traproll		Snare	S31	SD HipHop
				Tom1	380	HipHop Tom 2
				Tom1Rim	406	Scratch 4
				Tom2	380	HipHop Tom 2
				Tom2Rim	404	Scratch 2
				Tom3	379	HipHop Tom 1
				Tom3Rim	351	Bell Tree
				Kick	K25	BD HipHop
				Hi-Hat	H07	HH HipHop
				Crash	385	Dance Crash 1
				Ride	R08	Electronic-Ride
				Tom4/Acc1	K27	BD BrokenBeats
				Acc2	386	Dance Crash 2
				Acc3	---	
	2	Drums & Bass		Snare	S35	SD Drum'Bass
				Tom1	417	D&B Hit
				Tom1Rim	418	D&B Industry
				Tom2	417	D&B Hit
				Tom2Rim	418	D&B Industry
				Tom3	443	808 BD Bass
				Tom3Rim	419	D&B Noise Up
				Kick	K34	BD Drum'Bass
				Hi-Hat	H12	HH Dirty
				Crash	388	Dirty Crash 2
				Ride	R08	Electronic-Ride
				Tom4/Acc1	441	Bass 1
				Acc2	424	AirHorn
				Acc3	---	
	3	Dub		Snare	S30	SD Dubstep
				Tom1	415	Dub Hit 1
				Tom1Rim	411	Compu Noise
				Tom2	445	EDM Bass Hit
				Tom2Rim	416	Dub Hit 2
				Tom3	442	Bass 2
				Tom3Rim	448	Dub Bass SEQ
				Kick	K24	BD Dubstep
				Hi-Hat	H06	HH Dubstep
				Crash	433	Dub Explosion
				Ride	R08	Electronic-Ride
				Tom4/Acc1	K35	BD Dubstep
				Acc2	388	Dirty Crash 2
				Acc3	---	
	4	Analog		Snare	S36	SD Analog 808
				Tom1	381	808 Tom
				Tom1Rim	393	808 Cowbell
				Tom2	381	808 Tom
				Tom2Rim	394	808 Conga
				Tom3	381	808 Tom
				Tom3Rim	395	808 Clap
				Kick	K28	BD Analog 808
				Hi-Hat	H13	HH Analog 808
				Crash	392	808 Cymbal 2
				Ride	391	808 Cymbal 1
				Tom4/Acc1	381	808 Tom
				Acc2	392	808 Cymbal 2
				Acc3	---	
	5	80's Simm		Snare	S37	SD SIMMONS
				Tom1	T90	SIMMONS Tom
				Tom1Rim	378	SIMMONS Rim
				Tom2	T90	SIMMONS Tom
				Tom2Rim	378	SIMMONS Rim
				Tom3	T90	SIMMONS Tom
				Tom3Rim	378	SIMMONS Rim
				Kick	K29	BD SIMMONS
				Hi-Hat	H14	HH SIMMONS
				Crash	385	Dance Crash 1
				Ride	384	Dance Ride 2
				Tom4/Acc1	T90	SIMMONS Tom
				Acc2	386	Dance Crash 2
				Acc3	---	

Category	#	DrumKitName	AMBIENCE	Pad Assign	#	Inst Name
HYBRID	1	Massonator		Snare	S38	SD with Hihat
				Tom1	T101	Dance SD for TM Pad
				Tom1Rim	443	808 BD Bass
				Tom2	443	808 BD Bass
				Tom2Rim	336	Wood Block H
				Tom3	376	Kick & Low SD
				Tom3Rim	351	Bell Tree
				Kick	K30	BD22-MJP
				Hi-Hat	H02	HH14-Pst-2002
				Crash	C01	Crash16-Sbn-AAX
				Ride	R12	Tambourine for RD Pad
				Tom4/Acc1	443	808 BD Bass
				Acc2	414	Record Noise
				Acc3	---	
	2	Hipster		Snare	S09	SD14x35-FreeFloat2 Brass
				Tom1	T77	TM-SD10x6-Popcorn Mple
				Tom1Rim	316	Bongo Stick H
				Tom2	T78	TM-SD14x65-Kapur Fiber
				Tom2Rim	317	Bongo Stick L
				Tom3	T79	TM-SD14x8-FreeFit Maho
				Tom3Rim	345	Tambourine
				Kick	K04	BD20x14-Wood Fiber
				Hi-Hat	H02	HH14-Pst-2002
				Crash	C08	CR-Ride20-Zld-K Sizzle
				Ride	R03	Ride22-Pst-2002
				Tom4/Acc1	T17	Tom14x14-Reference Pure
				Acc2	C18	FXCym10-Sbn-Chppr
				Acc3	---	
	3	Tip Jar		Snare	S44	Cajon for SD Pad
				Tom1	T80	Roto Tom H
				Tom1Rim	348	Triangle Velo Open/Mute
				Tom2	T81	Roto Tom M
				Tom2Rim	455	Pan Flute SEQ
				Tom3	T82	Roto Tom L
				Tom3Rim	322	Shaker
				Kick	K33	Cajon Basstone
				Hi-Hat	H17	Pandeiro for HH Pad
				Crash	C12	Splash10-Pst-2002
				Ride	R03	Ride22-Pst-2002
				Tom4/Acc1	T91	Timbale H for TM Pad
				Acc2	345	Tambourine
				Acc3	---	
4	Toy Box		Snare	S01	SD10x6-Popcorn Maple	
			Tom1	382	Toy Box Tom	
			Tom1Rim	426	Coin	
			Tom2	381	808 Tom	
			Tom2Rim	336	Wood Block H	
			Tom3	315	Timbale H	
			Tom3Rim	337	Wood Block L	
			Kick	K21	BD Toy Box	
			Hi-Hat	H10	HH Industry	
			Crash	C19	FXCym12-Sbn-MxStx	
			Ride	426	Coin	
			Tom4/Acc1	396	Industry 1	
			Acc2	C13	China19-Sbn-Holy	
			Acc3	---		
5	Elements		Snare	S34	SD Dance	
			Tom1	T93	Conga for TM Pad	
			Tom1Rim	314	Conga CloseSlap	
			Tom2	T92	Timbale L for TM Pad	
			Tom2Rim	315	Timbale H	
			Tom3	T36	Tom16x16-Session	
			Tom3Rim	398	Industry 3	
			Kick	K22	BD Dance	
			Hi-Hat	H11	HH Dance	
			Crash	390	909 Crash	
			Ride	383	Dance Ride 1	
			Tom4/Acc1	401	Chord 1	
			Acc2	C19	FXCym12-Sbn-MxStx	
			Acc3	---		

Category	#	DrumKitName	AMBIENCE	Pad Assign	#	Inst Name
WORLD	1	Havana		Snare	S40	Conga for SD Pad
				Tom1	T91	Timbale H for TM Pad
				Tom1Rim	310	Chacha Bell
				Tom2	T92	Timbale L for TM Pad
				Tom2Rim	311	Paila & Clave
				Tom3	T94	Tumba for TM Pad
				Tom3Rim	312	Tumba Slap
				Kick	K33	Cajon Basstone
				Hi-Hat	H15	Guiro for HH Pad
				Crash	C01	Crash16-Sbn-AAX
				Ride	R10	Cowbell 2 for RD Pad
				Tom4/Acc1	T29	Tom14x14-Crystal Beat
				Acc2	322	Shaker
				Acc3	---	
	2	Bossa		Snare	S39	SD High Pitch
				Tom1	321	Tamborim
				Tom1Rim	345	Tambourine
				Tom2	T95	Pandeiro for TM Pad
				Tom2Rim	358	Pandeiro Jingle
				Tom3	318	Surdo 2
				Tom3Rim	320	Surdo Rim
				Kick	K32	Surdo 1
				Hi-Hat	H18	Shaker for HH Pad
				Crash	C20	Recoreco for CR Pad
				Ride	R14	Agogo for RD Pad
				Tom4/Acc1	323	Berimbau
				Acc2	C12	Splash10-Pst-2002
				Acc3	---	
	3	Afro Blu		Snare	S41	Djembe for SD Pad
				Tom1	T97	JunJun 1 for TM Pad
				Tom1Rim	353	African Maraca Short
				Tom2	T98	JunJun 2 for TM Pad
				Tom2Rim	361	Ceramic Jingle Short
				Tom3	T96	DunDun for TM Pad
				Tom3Rim	335	Udu Bell
				Kick	334	Udu Open 2
				Hi-Hat	H19	Chekere for HH Pad
				Crash	C21	African Maraca for CR
				Ride	R15	Baraphone for RD Pad
				Tom4/Acc1	333	Udu Open 1
				Acc2	360	Ceramic Jingle Long
				Acc3	---	
	4	In Mid East		Snare	S42	Darabuka for SD Pad
Tom1				T100	Req for TM Pad	
Tom1Rim				359	Req Jingle	
Tom2				T99	Daf for TM Pad	
Tom2Rim				327	Daf Rim	
Tom3				329	Tabla	
Tom3Rim				330	Baya	
Kick				K31	Djembe Basstone	
Hi-Hat				H20	Sagat for HH Pad	
Crash				357	Mini Tamtam	
Ride				R11	African Maraca for RDPad	
Tom4/Acc1				326	Tabil	
Acc2				331	Tambura	
Acc3				---		
5	Orch Kit		Snare	S25	SD15x5-SensiTone Mahogny	
			Tom1	T83	Timpani	
			Tom1Rim	338	WoodBlock amb H	
			Tom2	T83	Timpani	
			Tom2Rim	339	WoodBlock amb M	
			Tom3	T83	Timpani	
			Tom3Rim	340	WoodBlock amb L	
			Kick	K20	BD Orchestral	
			Hi-Hat	H02	HH14-Pst-2002	
			Crash	350	Sleigh Bell	
			Ride	R07	Orch Cymbal	
			Tom4/Acc1	362	Chinese Gong	
			Acc2	351	Bell Tree	
			Acc3	---		

Inst List

Inst Type	#	Inst Name	W	A
Snare	S01	SD10x6-Popcorn Maple	○	○
	S02	SD10x6-off-Popcorn Maple	○	○
	S03	SD12x7-Soprano Maple	○	○
	S04	SD12x7-off-Soprano Maple	○	○
	S05	SD12x7-Vintage Maple	○	○
	S06	SD13x3-Piccolo Steel	○	○
	S07	SD13x65-Reference 20ply	○	○
	S08	SD14x35-FreeFloat1 Brass	○	○
	S09	SD14x35-FreeFloat2 Brass	○	○
	S10	SD14x5-Cast Aluminium	○	○
	S11	SD14x5-Reference Pure	○	○
	S12	SD14x5-SensiTone Steel	○	○
	S13	SD14x55-Masters Maple	○	○
	S14	SD14x55-Modern Maple	○	○
	S15	SD14x55-Vintage Maple	○	○
	S16	SD14x65-Kapur Fiber	○	○
	S17	SD14x65-off-Kapur Fiber	○	○
	S18	SD14x65-Masters Birch	○	○
	S19	SD14x65-Reference Brass	○	○
	S20	SD14x65-SensiTone Brass	○	○
	S21	SD14x65-Modern Brass	○	○
	S22	SD14x65-Vintage Brass	○	○
	S23	SD14x65-Session Kapur	○	○
	S24	SD14x8-FreeFloat Mahogany	○	○
	S25	SD15x5-SensiTone Mahogany	○	○
	S26	SD15x5-Vintage Mahogany	○	○
	S27	SD14x12-Pipe Band Birch	○	○
	S28	SD14x5-w/Cup Chime	○	○
	S29	SD Breaks	○	
	S30	SD Dubstep	○	
	S31	SD HipHop	○	
	S32	SD Retro	○	
	S33	SD BrokenBeats	○	
	S34	SD Dance	○	
	S35	SD Drum'Bass	○	
	S36	SD Analog 808	○	
	S37	SD SIMMONS		
	S38	SD with Hihat	○	
	S39	SD High Pitch	○	○
	S40	Conga for SD Pad	○	
	S41	Djembe for SD Pad	○	
	S42	Darabuka for SD Pad	○	
	S43	Pandeiro for SD Pad	○	
	S44	Cajon for SD Pad	○	
Tom	T01	Tom12x8-Masters Maple	○	○
	T02	Tom13x9-Masters Maple	○	○
	T03	Tom14x14-Masters Maple	○	○
	T04	Tom15x15-Masters Maple	○	○
	T05	Tom16x16-Masters Maple	○	○
	T06	Tom18x16-Masters Maple	○	○
	T07	Tom10x8-Reference	○	○
	T08	Tom12x9-Reference	○	○

Inst Type	#	Inst Name	W	A
	T09	Tom13x10-Reference	○	○
	T10	Tom16x16-Reference	○	○
	T11	Tom16x16-Reference L	○	○
	T12	Tom18x16-Reference	○	○
	T13	Tom18x16-Reference L	○	○
	T14	Tom8x7-Reference Pure	○	○
	T15	Tom10x7-Reference Pure	○	○
	T16	Tom12x8-Reference Pure	○	○
	T17	Tom14x14-Reference Pure	○	○
	T18	Tom16x16-Reference Pure	○	○
	T19	Tom12x8-Wood Fiber	○	○
	T20	Tom13x9-Wood Fiber	○	○
	T21	Tom14x14-Wood Fiber	○	○
	T22	Tom16x16-Wood Fiber	○	○
	T23	Tom10x7-RF Blu Note	○	○
	T24	Tom12x8-RF Blu Note	○	○
	T25	Tom14x14-RF Blu Note	○	○
	T26	Tom14x14-RF Blu Note L	○	○
	T27	Tom10x7-Crystal Beat	○	○
	T28	Tom12x8-Crystal Beat	○	○
	T29	Tom14x14-Crystal Beat	○	○
	T30	Tom16x16-Crystal Beat	○	○
	T31	Tom18x16-Crystal Beat	○	○
	T32	Tom18x16-Crystal Beat L	○	○
	T33	Tom10x7-Session	○	○
	T34	Tom12x8-Session	○	○
	T35	Tom14x14-Session	○	○
	T36	Tom16x16-Session	○	○
	T37	Tom16x16-Session L	○	○
	T38	Tom10x7-Masters F-Call	○	○
	T39	Tom12x8-Masters F-Call	○	○
	T40	Tom13x9-Masters F-Call	○	○
	T41	Tom14x14-Masters F-Call	○	○
	T42	Tom16x16-Masters F-Call	○	○
	T43	Tom10x8-RF Sandman	○	○
	T44	Tom12x9-RF Sandman	○	○
	T45	Tom13x10-RF Sandman	○	○
	T46	Tom16x16-RF Sandman	○	○
	T47	Tom18x16-RF Sandman	○	○
	T48	Tom18x16-RF Sandman L	○	○
	T49	Tom10x7-Masters Surface	○	○
	T50	Tom12x8-Masters Surface	○	○
	T51	Tom13x9-Masters Surface	○	○
	T52	Tom14x14-Masters Surface	○	○
	T53	Tom16x16-Masters Surface	○	○
	T54	Tom10x7-Session Resnor	○	○
	T55	Tom12x8-Session Resnor	○	○
	T56	Tom14x14-Session Resnor	○	○
	T57	Tom16x16-Session Resnor	○	○
	T58	Tom16x16-Session Rsnr L	○	○
	T59	Tom10x7-RF Funk n Soul	○	○
	T60	Tom12x8-RF Funk n Soul	○	○
	T61	Tom14x14-RF Funk n Soul	○	○
	T62	Tom14x14-RF FunkSoul L	○	○
	T63	Tom10x7-RF NOLA Funk	○	○

Inst Type	#	Inst Name	W	A
	T64	Tom12x8-RF NOLA Funk	○	○
	T65	Tom14x14-RF NOLA Funk	○	○
	T66	Tom14x14-RF NOLA Funk L	○	○
	T67	Tom10x7-CRB Ramble	○	○
	T68	Tom12x8-CRB Ramble	○	○
	T69	Tom14x14-CRB Ramble	○	○
	T70	Tom16x16-CRB Ramble	○	○
	T71	Tom18x16-CRB Ramble	○	○
	T72	Tom12x8-FW Funkafize	○	○
	T73	Tom13x9-FW Funkafize	○	○
	T74	Tom14x14-FW Funkafize	○	○
	T75	Tom16x16-FW Funkafize	○	○
	T76	GongDrum20 Ref-Pure	○	○
	T77	TM-SD10x6-Popcorn Mple	○	○
	T78	TM-SD14x65-Kapur Fiber	○	○
	T79	TM-SD14x8-FreeFit Maho	○	○
	T80	Roto Tom H	○	
	T81	Roto Tom M	○	
	T82	Roto Tom L	○	
	T83	Timpani	○	
	T84	Electronic-Tom1 H	○	
	T85	Electronic-Tom1 M	○	
	T86	Electronic-Tom1 L	○	
	T87	Electronic-Tom2 H	○	
	T88	Electronic-Tom2 M	○	
	T89	Electronic-Tom2 L	○	
	T90	SIMMONS Tom	○	
	T91	Timbale H for TM Pad	○	
	T92	Timbale L for TM Pad	○	
	T93	Conga for TM Pad	○	
	T94	Tumba for TM Pad	○	
	T95	Pandeiro for TM Pad	○	
	T96	DunDun for TM Pad	○	
	T97	JunJun 1 for TM Pad	○	
	T98	JunJun 2 for TM Pad	○	
	T99	Daf for TM Pad	○	
	T100	Req for TM Pad	○	
	T101	Dance SD for TM Pad	○	
Kick	K01	BD22x16-Masters Maple		○
	K02	BD20x16-Reference		○
	K03	BD22x18-Reference		○
	K04	BD20x14-Wood Fiber		○
	K05	BD22x14-Wood Fiber		○
	K06	BD24x14-Wood Fiber		○
	K07	BD22x18-Reference Pure		○
	K08	BD18x14-RF Blu Note		○
	K09	BD18x14-RF Funk n Soul		○
	K10	BD22x16-Crystal Beat		○
	K11	BD24x16-Crystal Beat		○
	K12	BD22x16-Session		○
	K13	BD22x16-Masters F-Call		○
	K14	BD22x18-RF Sandman		○
	K15	BD22x16-Masters Surface		○
	K16	BD22x16-SSC Reznor		○
	K17	BD22x16-SSC NOLA Funk		○

Inst Type	#	Inst Name	W	A
	K18	BD22x16-CRB Ramble		○
	K19	BD22x18-RF Funkafize		○
	K20	BD Orchestral		
	K21	BD Toy Box		
	K22	BD Dance		
	K23	BD Breaks		
	K24	BD Dubstep		
	K25	BD HipHop		
	K26	BD Retro		
	K27	BD BrokenBeats		
	K28	BD Analog 808		
	K29	BD SIMMONS		
	K30	BD22-MJP		
	K31	Djembe Basstone		
	K32	Surdo 1		
	K33	Cajon Basstone		
	K34	BD Drum'Bass		
	K35	BD Dubvox		
	K36	NuDub Kick		
Hi-Hat	H01	HH13-Sbn-HHX		○
	H02	HH14-Pst-2002		○
	H03	HH15-Zld-K		○
	H04	HH16-Sbn-AAX		○
	H05	HH Breaks		
	H06	HH Dubstep		
	H07	HH HipHop		
	H08	HH Retro		
	H09	HH BrokenBeats		
	H10	HH Industry		
	H11	HH Dance		
	H12	HH Dirty		
	H13	HH Analog 808		
	H14	HH SIMMONS		
	H15	Guiro for HH Pad		
	H16	RecoReco for HH Pad		
	H17	Pandeiro for HH Pad		
	H18	Shaker for HH Pad		
	H19	Chekere for HH Pad		
	H20	Sagat for HH Pad		
	H21	Dirty HH		
Crash	C01	Crash16-Sbn-AAX		○
	C02	Crash18-Sbn-AAX		○
	C03	Crash16-Zld-K		○
	C04	Crash18-Zld-K		○
	C05	Crash19-Pst-2002		○
	C06	Crash22-Pst-2002		○
	C07	CR-Ride19-Sbn-HHX		○
	C08	CR-Ride20-Zld-K Sizzle		○
	C09	Crash16-Sbn-OZn		○
	C10	Crash18-Sbn-Rcktgn		○
	C11	Splash10-Sbn-AAX		○
	C12	Splash10-Pst-2002		○
	C13	China19-Sbn-Holy		○
	C14	China20-Pst-2002		○
	C15	FXCym12-Sbn-IceB		○

Inst Type	#	Inst Name	W	A
	C16	FXCym7-Sbn-Chime		○
	C17	FXCym8-Sbn-Chime		○
	C18	FXCym10-Sbn-Chmpr		○
	C19	FXCym12-Sbn-MxStx		○
	C20	Recoreco for CR Pad		
	C21	African Maraca for CR		
	C22	Cowbell CMP for CR Pad		○
	C23	Cowbell H M for CR Pad		○
	C24	Cowbell L M for CR Pad		○
Ride	R01	Ride19-Sbn-HHX		○
	R02	Ride20-Sbn-AAAX		○
	R03	Ride22-Pst-2002		○
	R04	Ride22-Zld-KERO		○
	R05	Ride20-Zld-K		○
	R06	Ride20-Zld-K Sizzle		○
	R07	Orch Cymbal		
	R08	Electronic-Ride		
	R09	Cowbell 1 for RD Pad		
	R10	Cowbell 2 for RD Pad		
	R11	African Maraca for RDPad		
	R12	Tambourine for RD Pad		
	R13	Triangle for RD Pad		
	R14	Agogo for RD Pad		
	R15	Baraphone for RD Pad		
	R16	Karimba for RD Pad		
Misc	001	*SD10x6-Popcorn Maple 1		○
	002	*SD10x6-Popcorn Maple 2		○
	003	*SD10x6-off-PopcornMpl 1		○
	004	*SD10x6-off-PopcornMpl 2		○
	005	*SD12x7-Soprano Maple 1		○
	006	*SD12x7-Soprano Maple 2		○
	007	*SD12x7-off-SopranoMpl 1		○
	008	*SD12x7-off-SopranoMpl 2		○
	009	*SD12x7-Vintage Maple 1		○
	010	*SD12x7-Vintage Maple 2		○
	011	*SD13x3-Piccolo Steel 1		○
	012	*SD13x3-Piccolo Steel 2		○
	013	*SD13x3-off-PicloSteel 1		○
	014	*SD13x3-off-PicloSteel 2		○
	015	*SD13x65-Ref 20ply 1		○
	016	*SD13x65-Ref 20ply 2		○
	017	*SD14x35-FreeFlt1Brass 1		○
	018	*SD14x35-FreeFlt1Brass 2		○
	019	*SD14x35-FreeFlt2Brass 1		○
	020	*SD14x35-FreeFlt2Brass 2		○
	021	*SD14x5-Cast Aluminium 1		○
	022	*SD14x5-Cast Aluminium 2		○
	023	*SD14x5-Reference Pure 1		○
	024	*SD14x5-Reference Pure 2		○
	025	*SD14x5-SensiTn Steel 1		○
	026	*SD14x5-SensiTn Steel 2		○
	027	*SD14x55-Masters Maple 1		○
	028	*SD14x55-Masters Maple 2		○
	029	*SD14x55-Modern Maple 1		○
	030	*SD14x55-Modern Maple 2		○

Inst Type	#	Inst Name	W	A
	031	*SD14x55-Vintage Maple 1		○
	032	*SD14x55-Vintage Maple 2		○
	033	*SD14x65-Kapur Fiber 1		○
	034	*SD14x65-Kapur Fiber 2		○
	035	*SD14x65-off-KapurFibr 1		○
	036	*SD14x65-off-KapurFibr 2		○
	037	*SD14x65-Masters Birch 1		○
	038	*SD14x65-Masters Birch 2		○
	039	*SD14x65-Ref Brass 1		○
	040	*SD14x65-Ref Brass 2		○
	041	*SD14x65-SensiTn Brass 1		○
	042	*SD14x65-SensiTn Brass 2		○
	043	*SD14x65-Modern Brass 1		○
	044	*SD14x65-Modern Brass 2		○
	045	*SD14x65-Vintage Brass 1		○
	046	*SD14x65-Vintage Brass 2		○
	047	*SD14x65-Session Kapur 1		○
	048	*SD14x65-Session Kapur 2		○
	049	*SD14x8-FreeFloat Maho 1		○
	050	*SD14x8-FreeFloat Maho 2		○
	051	*SD15x5-SensiTn Maho 1		○
	052	*SD15x5-SensiTn Maho 2		○
	053	*SD15x5-Vintage Maho 1		○
	054	*SD15x5-Vintage Maho 2		○
	055	*SD14x12-PipeBandBirch 1		○
	056	*SD14x12-PipeBandBirch 2		○
	057	*SD14x5-w/Cup Chime 1		○
	058	*SD14x5-w/Cup Chime 2		○
	059	*SD14x35-CrossStick FFB1		○
	060	*SD14x35-CrossStick FFB2		○
	061	*SD13x65-Cross Stick R20		○
	062	*SD14x5-Cross Stick CA		○
	063	*SD14x5-Cross Stick RP		○
	064	*SD14x5-Cross Stick STS		○
	065	*SD14x55-Cross Stick MM		○
	066	*SD14x55-Cross Stick MdM		○
	067	*SD14x55-Cross Stick VM		○
	068	*SD14x65-Cross Stick KF		○
	069	*SD14x65-off-CrossStk KF		○
	070	*SD14x65-Cross Stick MB		○
	071	*SD14x65-Cross Stick RB		○
	072	*SD14x65-CrossStick STB		○
	073	*SD14x65-Cross Stick VB		○
	074	*SD14x65-Cross Stick SK		○
	075	*SD14x8-Cross Stick FFM		○
	076	*SD15x5-Cross Stick STM		○
	077	*SD15x5-Cross Stick VM		○
	078	*SD14x12-CrossStick PPB		○
	079	*Tom12x8-Masters Maple		○
	080	*Tom12x8-Masters Mpl RS		○
	081	*Tom13x9-Masters Maple		○
	082	*Tom13x9-Masters Mpl RS		○
	083	*Tom14x14-Masters Maple		○
	084	*Tom14x14-Masters Mpl RS		○
	085	*Tom16x16-Masters Maple		○

Inst Type	#	Inst Name	W	A
	086	*Tom16x16-Masters Mpl RS		○
	087	*Tom10x8-Reference		○
	088	*Tom10x8-Reference RS		○
	089	*Tom12x9-Reference		○
	090	*Tom12x9-Reference RS		○
	091	*Tom13x10-Reference		○
	092	*Tom13x10-Reference RS		○
	093	*Tom16x16-Reference		○
	094	*Tom16x16-Reference RS		○
	095	*Tom18x16-Reference		○
	096	*Tom18x16-Reference RS		○
	097	*Tom8x7-Ref Pure		○
	098	*Tom8x7-Ref Pure RS		○
	099	*Tom10x7-Ref Pure		○
	100	*Tom10x7-Ref Pure RS		○
	101	*Tom12x8-Ref Pure		○
	102	*Tom12x8-Ref Pure RS		○
	103	*Tom14x14-Ref Pure		○
	104	*Tom14x14-Ref Pure RS		○
	105	*Tom14x14-Ref Pure L		○
	106	*Tom16x16-Ref Pure		○
	107	*Tom16x16-Ref Pure RS		○
	108	*Tom12x8-Wood Fiber		○
	109	*Tom12x8-Wood Fiber RS		○
	110	*Tom13x9-Wood Fiber		○
	111	*Tom13x9-Wood Fiber RS		○
	112	*Tom14x14-Wood Fiber		○
	113	*Tom14x14-Wood Fiber RS		○
	114	*Tom16x16-Wood Fiber		○
	115	*Tom16x16-Wood Fiber RS		○
	116	*Tom10x7-RF Blu Note		○
	117	*Tom10x7-RF Blu Note RS		○
	118	*Tom12x8-RF Blu Note		○
	119	*Tom12x8-RF Blu Note RS		○
	120	*Tom14x14-RF Blu Note		○
	121	*Tom14x14-RF Blu Note RS		○
	122	*Tom10x7-Crystal Beat		○
	123	*Tom10x7-Crystal Beat RS		○
	124	*Tom12x8-Crystal Beat		○
	125	*Tom12x8-Crystal Beat RS		○
	126	*Tom14x14-CrystalBeat		○
	127	*Tom14x14-CrystalBeat RS		○
	128	*Tom16x16-CrystalBeat		○
	129	*Tom16x16-CrystalBeat RS		○
	130	*Tom18x16-CrystalBeat		○
	131	*Tom18x16-CrystalBeat RS		○
	132	*Tom10x7-Session		○
	133	*Tom10x7-Session RS		○
	134	*Tom12x8-Session		○
	135	*Tom12x8-Session RS		○
	136	*Tom14x14-Session		○
	137	*Tom14x14-Session RS		○
	138	*Tom16x16-Session		○
	139	*Tom16x16-Session RS		○
	140	*Tom10x7-Masters F-Call		○

Inst Type	#	Inst Name	W	A
	141	*Tom10x7-MasterF-Call RS		○
	142	*Tom12x8-Masters F-Call		○
	143	*Tom12x8-MasterF-Call RS		○
	144	*Tom13x9-Masters F-Call		○
	145	*Tom13x9-MasterF-Call RS		○
	146	*Tom14x14-Msters F-Call		○
	147	*Tom14x14-MsterF-Call RS		○
	148	*Tom16x16-Msters F-Call		○
	149	*Tom16x16-MsterF-Call RS		○
	150	*Tom10x8-RF Sandman		○
	151	*Tom10x8-RF Sandman RS		○
	152	*Tom12x9-RF Sandman		○
	153	*Tom12x9-RF Sandman RS		○
	154	*Tom13x10-RF Sandman		○
	155	*Tom13x10-RF Sandman RS		○
	156	*Tom16x16-RF Sandman		○
	157	*Tom16x16-RF Sandman RS		○
	158	*Tom18x16-RF Sandman		○
	159	*Tom18x16-RF Sandman RS		○
	160	*Tom10x7-Mastr Surfce		○
	161	*Tom10x7-Mastr Surfce RS		○
	162	*Tom12x8-Mastr Surfce		○
	163	*Tom12x8-Mastr Surfce RS		○
	164	*Tom13x9-Mastr Surfce		○
	165	*Tom13x9-Mastr Surfce RS		○
	166	*Tom14x14-Mstr Surfce		○
	167	*Tom14x14-Mstr Surfce RS		○
	168	*Tom16x16-Mstr Surfce		○
	169	*Tom16x16-Mstr Surfce RS		○
	170	*Tom10x7-RF Funk n Soul		○
	171	*Tom10x7-RF Funk Soul RS		○
	172	*Tom12x8-RF Funk n Soul		○
	173	*Tom12x8-RF Funk Soul RS		○
	174	*Tom14x14-RF Funk n Soul		○
	175	*Tom14x14-RF FunkSoul RS		○
	176	*Tom10x7-RF NOLA Funk		○
	177	*Tom10x7-RF NOLA Funk RS		○
	178	*Tom12x8-RF NOLA Funk		○
	179	*Tom12x8-RF NOLA Funk RS		○
	180	*Tom14x14-RF NOLA Funk		○
	181	*Tom14x14-RF NOLAFunk RS		○
	182	*Tom10x7-CRB Ramble		○
	183	*Tom10x7-CRB Ramble RS		○
	184	*Tom12x8-CRB Ramble		○
	185	*Tom12x7-CRB Ramble RS		○
	186	*Tom14x14-CRB Ramble		○
	187	*Tom14x14-CRB Ramble RS		○
	188	*Tom16x16-CRB Ramble		○
	189	*Tom16x16-CRB Ramble RS		○
	190	*Tom18x16-CRB Ramble		○
	191	*Tom18x16-CRB Ramble RS		○
	192	*Tom12x8-FW Funkafiz		○
	193	*Tom12x8-FW Funkafiz RS		○
	194	*Tom13x9-FW Funkafiz		○
	195	*Tom13x9-FW Funkafiz RS		○

Inst Type	#	Inst Name	W	A
	196	*Tom14x14-FW Funkafiz		○
	197	*Tom14x14-FW Funkafiz RS		○
	198	*Tom16x16-FW Funkafiz		○
	199	*Tom16x16-FW Funkafiz RS		○
	200	*GongDrum20 Ref-Pure		○
	201	*HH13-Sbn-HHX-Closed 1		○
	202	*HH13-Sbn-HHX-Closed 2		○
	203	*HH13-Sbn-HHX-Open10% 1		○
	204	*HH13-Sbn-HHX-Open10% 2		○
	205	*HH13-Sbn-HHX-Open20% 1		○
	206	*HH13-Sbn-HHX-Open20% 2		○
	207	*HH13-Sbn-HHX-Open50% 1		○
	208	*HH13-Sbn-HHX-Open50% 2		○
	209	*HH13-Sbn-HHX-Open80% 1		○
	210	*HH13-Sbn-HHX-Open80% 2		○
	211	*HH13-Sbn-HHX-OpenFull 1		○
	212	*HH13-Sbn-HHX-OpenFull 2		○
	213	*HH14-Pst2002-Closed 1		○
	214	*HH14-Pst2002-Closed 2		○
	215	*HH14-Pst2002-Open10% 1		○
	216	*HH14-Pst2002-Open10% 2		○
	217	*HH14-Pst2002-Open20% 1		○
	218	*HH14-Pst2002-Open20% 2		○
	219	*HH14-Pst2002-Open30% 1		○
	220	*HH14-Pst2002-Open30% 2		○
	221	*HH14-Pst2002-Open50% 1		○
	222	*HH14-Pst2002-Open50% 2		○
	223	*HH14-Pst2002-OpenFull 1		○
	224	*HH14-Pst2002-OpenFull 2		○
	225	*HH15-Zld-K-Closed 1		○
	226	*HH15-Zld-K-Closed 2		○
	227	*HH15-Zld-K-Open10% 1		○
	228	*HH15-Zld-K-Open10% 2		○
	229	*HH15-Zld-K-Open20% 1		○
	230	*HH15-Zld-K-Open20% 2		○
	231	*HH15-Zld-K-Open30% 1		○
	232	*HH15-Zld-K-Open30% 2		○
	233	*HH15-Zld-K-Open50% 1		○
	234	*HH15-Zld-K-Open50% 2		○
	235	*HH15-Zld-K-OpenFull 1		○
	236	*HH15-Zld-K-OpenFull 2		○
	237	*HH16-Sbn-AAx-Closed 1		○
	238	*HH16-Sbn-AAx-Closed 2		○
	239	*HH16-Sbn-AAx-Open10% 1		○
	240	*HH16-Sbn-AAx-Open10% 2		○
	241	*HH16-Sbn-AAx-Open20% 1		○
	242	*HH16-Sbn-AAx-Open20% 2		○
	243	*HH16-Sbn-AAx-Open30% 1		○
	244	*HH16-Sbn-AAx-Open30% 2		○
	245	*HH16-Sbn-AAx-Open50% 1		○
	246	*HH16-Sbn-AAx-Open50% 2		○
	247	*HH16-Sbn-AAx-OpenFull 1		○
	248	*HH16-Sbn-AAx-OpenFull 2		○
	249	*Crash16-Sbn-AAx 1		○
	250	*Crash16-Sbn-AAx 2		○

Inst Type	#	Inst Name	W	A
	251	*Crash18-Sbn-AAx 1		○
	252	*Crash18-Sbn-AAx 2		○
	253	*Crash16-Zld-K 1		○
	254	*Crash16-Zld-K 2		○
	255	*Crash18-Zld-K 1		○
	256	*Crash18-Zld-K 2		○
	257	*Crash19-Pst-2002 1		○
	258	*Crash19-Pst-2002 2		○
	259	*Crash22-Pst-2002 1		○
	260	*Crash22-Pst-2002 2		○
	261	*Ride19-Sbn-HHX 1		○
	262	*Ride19-Sbn-HHX 2		○
	263	*Ride19-Sbn-HHX Bell		○
	264	*Ride20-Sbn-AAx 1		○
	265	*Ride20-Sbn-AAx 2		○
	266	*Ride20-Sbn-AAx Bell		○
	267	*Ride22-Pst-2002 1		○
	268	*Ride22-Pst-2002 2		○
	269	*Ride22-Pst-2002 Bell		○
	270	*Ride22-Zld-KERO 1		○
	271	*Ride22-Zld-KERO 2		○
	272	*Ride22-Zld-KERO Bell		○
	273	*Ride20-Zld-K 1		○
	274	*Ride20-Zld-K 2		○
	275	*Ride20-Zld-K Bell		○
	276	*Ride20-Zld-K Sizzle 1		○
	277	*Ride20-Zld-K Sizzle 2		○
	278	*Ride20-Zld-K SizzleBell		○
	279	*Crash16-Sbn-OZn 1		○
	280	*Crash16-Sbn-OZn 2		○
	281	*Crash18-Sbn-Rcktgn 1		○
	282	*Crash18-Sbn-Rcktgn 2		○
	283	*Splash10-Sbn-AAx 1		○
	284	*Splash10-Sbn-AAx 2		○
	285	*Splash10-Pst-2002 1		○
	286	*Splash10-Pst-2002 2		○
	287	*China19-Sbn-Holy 1		○
	288	*China19-Sbn-Holy 2		○
	289	*China20-Pst-2002 1		○
	290	*China20-Pst-2002 2		○
	291	*FXCym12-Sbn-IceB 1		○
	292	*FXCym12-Sbn-IceB 2		○
	293	*FXCym7-Sbn-Chime 1		○
	294	*FXCym7-Sbn-Chime 2		○
	295	*FXCym8-Sbn-Chime 1		○
	296	*FXCym8-Sbn-Chime 2		○
	297	*FXCym10-Sbn-Chppr		○
	298	*FXCym12-Sbn-MxStx		○
	299	Splash8-Sbn-Pro		
	300	Splash8-Sbn-AA		
	301	Splash10-Zld-K		
	302	Crash18-Sbn-HHX		
	303	Broken Cymbal Pile Up		
	304	Cowbell CMP Center		○
	305	Cowbell CMP Edge		○

Inst Type	#	Inst Name	W	A
	306	Cowbell H M Center		○
	307	Cowbell H M Edge		○
	308	Cowbell L M Center		○
	309	Cowbell L M Edge		○
	310	Chacha Bell		
	311	Paila & Clave		
	312	Tumba Slap		
	313	Tumba Basstone		
	314	Conga CloseSlap		
	315	Timbale H		
	316	Bongo Stick H		
	317	Bongo Stick L		
	318	Surdo 2		
	319	Surdo Mute		
	320	Surdo Rim		
	321	Tamborim		
	322	Shaker		
	323	Berimbau		
	324	Samba Whisle Long		
	325	Samba Whisle Short		
	326	Tabil		
	327	Daf Rim		
	328	Sagat		
	329	Tabla		
	330	Baya		
	331	Tambura		
	332	Talking Drum		
	333	Udu Open 1		
	334	Udu Open 2		
	335	Udu Bell		
	336	Wood Block H		
	337	Wood Block L		
	338	WoodBlock amb H		
	339	WoodBlock amb M		
	340	WoodBlock amb L		
	341	Templeblock H		
	342	Templeblock L		
	343	Clave H		○
	344	Clave L		○
	345	Tambourine		
	346	Triangle Open		
	347	Triangle Mute		
	348	Triangle Velo Open/Mute		
	349	Jingle Bell		
	350	Sleigh Bell		
	351	Bell Tree		
	352	African Maraca Long		
	353	African Maraca Short		
	354	Sheep Bell H		
	355	Sheep Bell L		
	356	Hihat Velo Open/Close		
	357	Mini Tamtam		
	358	Pandeiro Jingle		
	359	Req Jingle		
	360	Ceramic Jingle Long		

Inst Type	#	Inst Name	W	A
	361	Ceramic Jingle Short		
	362	Chinese Gong		
	363	Vibraslap		
	364	Flexatone		
	365	CupChime Tree		
	366	Sarna Bell		
	367	Japanese Ohdaiko		
	368	Japanese Ohdaiko Fuchi		
	369	Japanese Okedaiko		
	370	Japanese Okedaiko Fuchi		
	371	Japanese Shimedaiko		
	372	Japanese Shimedaiko Fuch		
	373	Japanese Atarigane		
	374	Japanese Chappa		
	375	Suzu		
	376	Kick & Low SD		
	377	Drum'Bass SD		
	378	SIMMONS Rim		
	379	HipHop Tom 1		
	380	HipHop Tom 2		
	381	808 Tom		
	382	Toy Box Tom		
	383	Dance Ride 1		
	384	Dance Ride 2		
	385	Dance Crash 1		
	386	Dance Crash 2		
	387	Dirty Crash 1		
	388	Dirty Crash 2		
	389	Retro Crash		
	390	909 Crash		
	391	808 Cymbal 1		
	392	808 Cymbal 2		
	393	808 Cowbell		
	394	808 Conga		
	395	808 Clap		
	396	Industry 1		
	397	Industry 2		
	398	Industry 3		
	399	Industry 4		
	400	Industry 5		
	401	Chord 1		
	402	Chord 2		
	403	Scratch 1		
	404	Scratch 2		
	405	Scratch 3		
	406	Scratch 4		
	407	Hand Clap		
	408	Hand Clap Real		
	409	Vocorder Voice 1		
	410	Vocorder Voice 2		
	411	Compu Noise		
	412	Synth Quark		
	413	Random Glitch		
	414	Record Noise		
	415	Dub Hit 1		

Inst Type	#	Inst Name	W	A
	416	Dub Hit 2		
	417	D&B Hit		
	418	D&B Industry		
	419	D&B Noise Up		
	420	D&B Noise Down		
	421	Dub SE 1		
	422	Dub SE 2		
	423	Bell SE		
	424	AirHorn		
	425	Reverse Cymbal		
	426	Coin		
	427	BD+Splash		
	428	Babbling Stream		
	429	Thunder		
	430	Cannon		
	431	Explosion		
	432	Blast		
	433	Dub Explosion		
	434	Break Down		
	435	Impact		
	436	Rock Perc		
	437	Sub Bang		
	438	Truck Door		
	439	Needle		
	440	EDM Perc		
	441	Bass 1		
	442	Bass 2		
	443	808 BD Bass		
	444	909 BD Bass		
	445	EDM Bass Hit		
	446	Dub Bass		
	447	EDM Bass SEQ		
	448	Dub Bass SEQ		
	449	SynthBass SEQ 1		
	450	SynthBass SEQ 2		
	451	Ac Bass SEQ		
	452	Tronik Kick SEQ		
	453	Synth SE SEQ		
	454	Miltone SEQ		
	455	Pan Flute SEQ		
	456	Xylophone SEQ		
	457	Baraphone SEQ		
	458	Angklung SEQ		
	459	Mute Guitar SEQ		

W: WAVE Trigger Technology enabled.

A: Ambience function enabled.

MFX Type List

MFX Type	Parameter	BPM Sync
OFF		
Basic Comp	Sens	
	Attack	
	Level	
Attack Comp	Sens	
	Attack	
	Level	
Overdrive 1	Gain	
	Level	
Overdrive 2	Gain	
	Level	
Tube Drive	Gain	
	Level	
Radio Crunch	Gain	
	Level	
Distortion	Gain	
	Level	
Rich Hall	Time	
	Wet Level	
Plate Reverb	Time	
	Wet Level	
Small Room	Time	
	Wet Level	
Early Reflections	Time	
	Wet Level	
Chorus	Speed	
	Depth	
Short Delay Chorus	Delay Time	
	Speed	
	Depth	
Slow Flanger	Speed	
	Depth	
Fast Flanger	Speed	
	Depth	
Slow Phaser	Speed	
	Depth	
Fast Phaser	Speed	
	Depth	
Ring Mod 1	Freq	
	Dry/Wet	
Ring Mod 2	Freq	
	Dry/Wet	
Sync Delay 1	Feedback	○
	Wet Level	

MFX Type	Parameter	BPM Sync
Sync Delay 2	Feedback	○
	Wet Level	
Sync Delay 3	Feedback	○
	Wet Level	
Sync Delay LR 1	L Feedback	○
	R Feedback	
	Wet Level	
Sync Delay LR 2	L Feedback	○
	R Feedback	
	Wet Level	
Sync X-Delay LR	L Feedback	○
	R Feedback	
	Wet Level	
Short Delay	Delay Time	
	Feedback	
	Wet Level	
Short X-Delay LR	L Delay Time	
	R Feedback	
	Wet Level	
Mod Delay	Delay Time	
	Feedback	
	Wet Level	
Mod X-Delay LR	L Delay Time	
	R Delay Time	
	Wet Level	
Tape Echo	Delay Time	
	Feedback	
	Wet Level	
Radio Filter LP	Cutoff	
	Resonance	
Radio Filter HP	Cutoff	
	Resonance	
Radio Filter BP	Cutoff	
	Resonance	
Decimator	Freq	
	Dry/Wet	
Lo-Fi Wah	Cutoff	
	AutoSens	
	Dry/Wet	
Auto Wah	Cutoff	
	AutoSens	
	Dry/Wet	

Metronome sound list

1	Click
2	Claves
3	Bongo
4	Wood
5	Cowbell
6	Tambourine
7	Hi-Hat
8	Female
9	Male
10	Metronome

Mixer block diagram

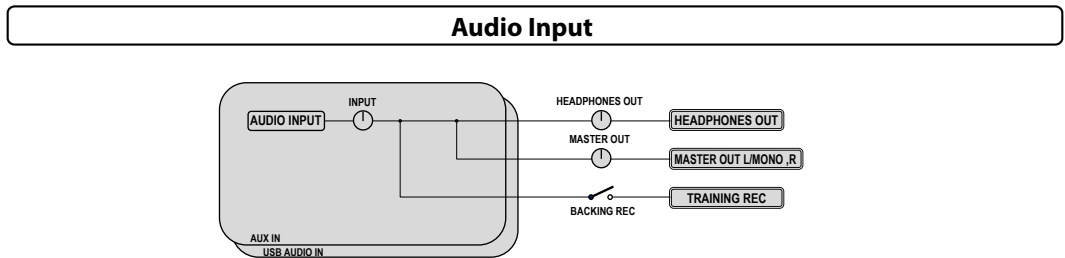
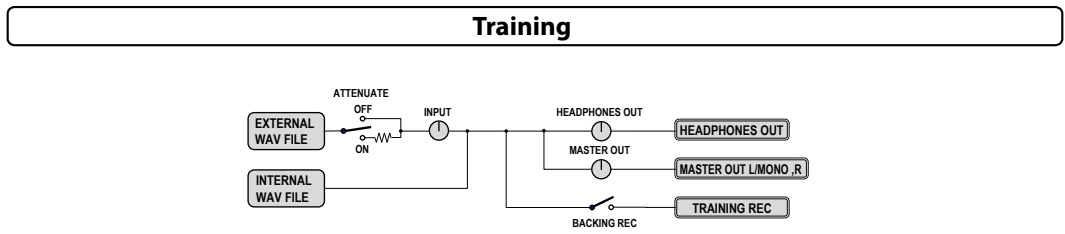
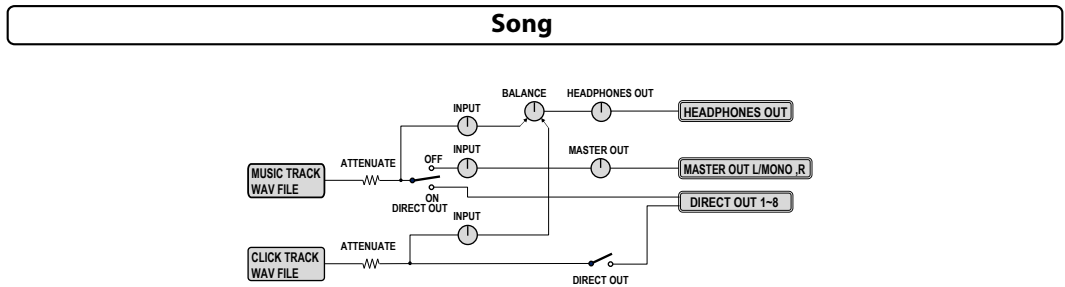
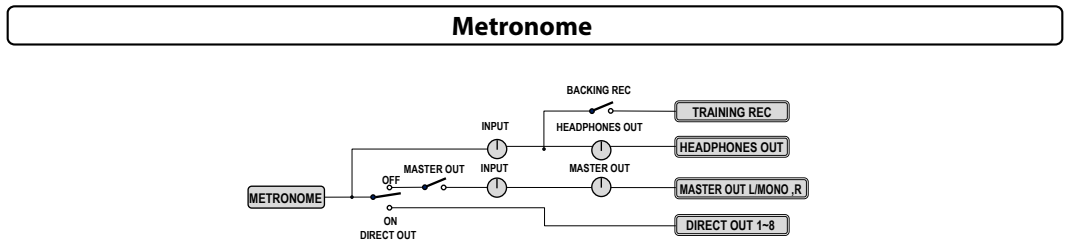
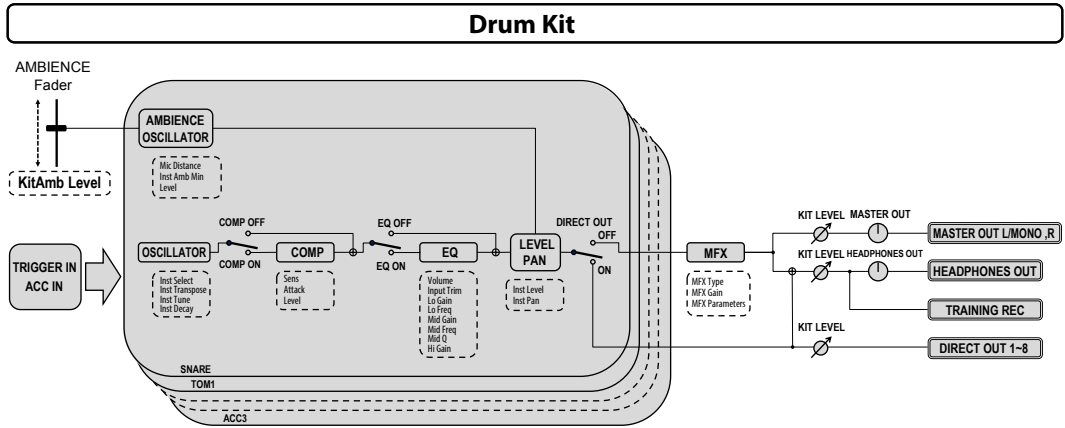

Files stored to USB flash drives

User Drum Kit Data File user_kit.dat	This file contains data stored for 50 user drum kits. Drum kits can be imported and exported one at a time. (→ p.49 “User Kit”)
Metronome Project Data File user_metronome.dat	Contains data stored for 50 metronome projects. (→ p.53 “Export All Metronome Projects”)
Song Project Data File user_song.dat	Contains data stored for 50 song projects.
All Systems File @@@@.alldata	This file contains all of the data stored. Multiple files can be stored. The “All Systems” filename can be renamed with a name up to 24 characters in length. (Default filename: BACKUP01.alldata) (→ p.51 “Export All Systems”)
Training REC WAV File	Use the training function to store the recorded file in the root directory. (→ p.52 “Export Internal Rec File”)
WAV File	Copy the WAV files used in song projects and the training function to the root directory of your USB flash memory from your computer.

The user data files shown below are stored in the “eMERGE/System” folder.

- User Drum Kit Data File
- Metronome Project Data File
- Song Project Data File
- All Systems File

Pad Assignment Chart

Instrument Type		Snare	Tom	Kick	Hihat	Crash	Ride	Misc
Trig	PAD	--	--	--	--	--	--	--
Snare	EM-14S	○	-	△	-	-	-	△
	Other	△*2	-	△*2	-	-	-	△*3
Tom1,2,3	EM-10,12,14T	-	○	△	-	-	-	△
	Other	-	△*2	△*2	-	-	-	△*3
/Rim	--	-	-	○	-	-	-	○
Kick	EM-KCPC/EBD	-	-	○	-	-	-	○
	Other	-	-	△*2	△*2	-	-	△*3
Hi-Hat	EM-14HH	-	-	△	○	-	-	△
	Other	-	-	△*2	△*2	-	-	△*3
Crash	EM-15C	-	-	△	-	○	-	△
	EM-18R	-	-	△	-	△*1	-	△
	Other	-	-	△*2	-	△*2	-	△*3
Ride	EM-18R	-	-	△	-	-	○	△
	Other	-	-	△*2	-	-	△*2	△*3
Tom4/ACC1	EM-14S	-	△	△	-	△	-	△
	EM-10,12,14T	-	○	△	-	△	-	△
	EM-15C	-	△	△	-	○	-	△
	EM-18R	-	△	△	-	△*1	-	△
	EM-KCPC/EBP	-	△	○	-	△	-	○
	Other	-	△*2	△*2	-	△*2	-	△*3
ACC2, 3	EM-14S	-	-	△	-	△	-	△
	EM-10,12,14T	-	-	△	-	△	-	△
	EM-15C	-	-	△	-	○	-	△
	EM-18R	-	-	△	-	△*1	-	△
	EM-KCPC/EBP	-	-	○	-	△	-	○
	Other	-	-	△*2	-	△*2	-	△*3

○: Works; △: Operations are restricted for the pad function; --: Cannot be assigned

*1: The edge cymbal sound will not be transmitted.

*2: Operations are restricted for the sound generator function. Adjust the parameters of the trigger pad to match the situation (→ p.40 "TRIGGER PAD"). Note that the sound of the pad may not be right, depending on which pad you use.

*3: Operations are not restricted for the sound generator function. Adjust the parameters of the trigger pad to match the situation (→ p.40 "TRIGGER PAD"). Note that the sound of the pad may not be right, depending on which pad you use.

Specifications

Number of drum kits	85 (including user kits)
Sound generator	PCM, physical modeling
Playable data format	WAV files (PCM: 44.1 kHz, 16-bit, max. 4 hours, stereo or mono)
Display	240×64 dots (backlit LCD)
Connection jacks	MASTER OUT L/MONO, R jacks (6.3 mm phone jack, unbalanced), DIRECT OUT 1–8 jacks (6.3 mm phone jack, unbalanced), Ⓜ (Headphones) jack (6.3 mm stereo phone jack), MIDI OUT connector, TO PC port, TO MEMORY DRIVE port (A USB flash drive of up to 2 TB in size can be used.), AUX IN jack (3.5mm stereo mini phone jack), TRIGGER IN jack, ACC IN (TOM4/ACC1, ACC2, ACC3) jacks (6.3 mm TRS phone jack), DC 12V jack (⚡)
Controls	Power button, AMBIENCE fader, MASTER OUT knob, TEMPO knob, INPUT knob, HEADPHONES OUT knob, BALANCE knob, Category buttons, Function buttons, dial, ENTER button, EXIT button, METRONOME ON/OFF button, SONG START/STOP button
Power supply	AC adapter, DC 12 V (⚡)
Power consumption	9.7W
Dimensions (W x D x H)	227 x 185 x 122mm / 8.94" x 7.28" x 4.80"
Weight	905g / 2.00lbs. (main unit only)
Included items	AC adapter, power cord, Breakout cable, Quick Start Guide

Operating requirements

Windows

Computers running Windows 10 or later, with a USB port (Intel chipset recommended)
Windows 10 (32-bit, 64-bit)

macOS

Apple Macintosh computer with Intel processor running macOS, with USB port
macOS version 10.11 or later

** Specifications and appearance are subject to change without notice for improvement.*

Pearl[®]

<http://www.pearldrums.com>

Products and specifications are subject to change without notice.